



DENTAL
INSTRUMENTS
CATALOG
2024-27
CATALOGUE | EDITION



ADEELNAZ IND IS A COMPANY LIKE NO OTHER BECAUSE IT IS A CONCEPT IN ITSELF. THE DENTAL EQUIPMENT MANUFACTURED BY US IS AN IMPORTANT CONTINUATION OF THE EXPERIENCE OF EVERY DENTIST. WE STRIVE TO OFFER A PRODUCT LINE THAT ASSURES END USERS OF EXCEPTIONAL QUALITY AND VALUE, ALONG WITH THE LEVEL OF SERVICE, SATISFACTION, AND COLLABORATION THAT HAS BECOME THE SYMBOL OF THE EVOLUTION OF SURGERY. BECAUSE WE BELIEVE IN LASTING AND CONSISTENT QUALITY, WE CANNOT COMPROMISE ON PRODUCT QUALITY.

OUR FACTORY IS LOCATED IN **SIALKOT PAKISTAN** AND WE HAVE BEEN MANUFACTURING AND SUPPLYING HIGH-QUALITY DIAGNOSTIC INSTRUMENTS (DENTAL INSTRUMENTS, SURGICAL INSTRUMENTS, AND OPHTHALMIC SURGERY) SINCE 2004 TO PREMIUM AND QUALITY CONSCIOUS CUSTOMERS WORLDWIDE.

ADEELNAZ IND IS MANAGED BY QUALIFIED STAFF AND OPERATES UNDER THE SUPERVISION OF THE HIGHLY QUALIFIED AND EXPERIENCED CO-FOUNDER, MUHAMMAD ISMAIL BOOTH. THANKS TO OUR LARGE STOCK, WE CAN DELIVER IN THE SHORTEST POSSIBLE TIME, ALLOWING OUR REGULAR CUSTOMERS TO MINIMIZE THEIR STORAGE NEEDS. WE OFFER OUR CUSTOMERS A COMPLETE SOLUTION OF DIAGNOSTIC TOOLS AT AFFORDABLE PRICES. OUR GOAL IS TO PROVIDE OUR CUSTOMERS WITH THE HIGHEST QUALITY PRODUCTS WITHIN THE AGREED TIME AND AT AN AFFORDABLE PRICE, GUARANTEEING THEIR SATISFACTION.

MISSION:"

OUR MISSION IS TO PRIORITIZE CUSTOMER NEEDS AND SATISFY CUSTOMERS WITH HIGH-QUALITY PRODUCTS AT AFFORDABLE PRICES.

VISION:"

OUR VISION IS TO BE THE BEST SURGICAL INSTRUMENT MANUFACTURER IN THE WORLD AND OFFER THE HIGHEST QUALITY PRODUCTS.

"OUR VALUE:

1) QUALITY AWARENESS IS ONE OF OUR MAIN CONCERNS, BECAUSE WE ALWAYS MONITOR THE QUALITY OF OUR PRODUCTS ACCORDING TO CUSTOMER DEMANDS, THUS SUPPLYING THE MOST COMPETITIVE PRODUCTS.

2) ADEELNAZ IND REACHES EXCELLENT AGREEMENTS WITH CUSTOMERS, IS AWARE OF ALL CUSTOMER NEEDS, AND CONTINUOUSLY PROVIDES HIGH-QUALITY PRODUCTS. WE TAKE OUR OBLIGATIONS TO OUR CUSTOMERS VERY SERIOUSLY AND KEEP OUR PROMISES WITH A FOCUS ON RAW MATERIALS, PRODUCT QUALITY, DELIVERY TIME, AND PRICE.

3) OUR GOAL IS TO CONTINUOUSLY IMPROVE THE QUALITY OF OUR PRODUCTS, AND WE ARE ALSO ENGAGED IN R&D TO IMPROVE THE QUALITY OF EXCELLENT PRODUCTS.

OUR STRATEGY:

OUR STRATEGY IS BASED ON THE CONCEPTS OF CONSISTENCY, CONTINUOUS IMPROVEMENT, AND SUPERIOR PRODUCT QUALITY. BECAUSE WE BELIEVE IN CONTRADICTION, WE CAN NEVER COMPROMISE ON THE QUALITY OF OUR PRODUCTS, THUS BUILDING HEALTHY RELATIONSHIPS WITH OUR VALUED CUSTOMERS. OUR CUSTOMERS CAN REST ASSURED THAT PRODUCT QUALITY WILL NOT CHANGE SIGNIFICANTLY BETWEEN ORDERS.

AT ADEELNAZ IND, WE MANUFACTURE QUALITY TOOLS THROUGH OUR SKILLED AND EXPERIENCED STAFF, AND WE ALSO SINCERELY WORK WITH OUR CUSTOMERS TO BETTER UNDERSTAND THEIR NEEDS. ADEELNAZ IND BELIEVES IN THE SUPERIOR QUALITY OF ITS PRODUCTS AND ASSURES ITS CUSTOMERS OF THIS DUE TO ITS COMMITMENT TO PROVIDING ITS CUSTOMERS WITH THE HIGHEST QUALITY TOOLS FOR THEIR BENEFIT. WE MANUFACTURE OUR TOOLS WITH GREAT CARE, WITH THE VALUE OF HUMAN LIFE IN MIND.

ADEELNAZ IND IS HAPPY TO OFFER ITS CUSTOMERS A GUARANTEE ON THE WORKMANSHIP AND MATERIALS OF ALL ITS PRODUCTS. IN ADDITION, OUR PRODUCTS ARE FDA APPROVED AND ISO 9001-2008, ISO 13485-2003, ISO 13485-2012, AND CE CERTIFIED.

WE ARE HONORED THAT YOU READ ABOUT US. THANK YOU

S01

EXTRACTING FORCEPS 01-31

MOUTH GAUGE 31-37

S02

ROOT ELEVATORS 38-61

LUXATING PDL ROOT ELEVATORS 62-63

FILLING INSTRUMENTS 64-68

DENTAL PROBES 69-72

S03

PERIODONTIA INSTRUMENTS 73-80

GRACEY CURETTES 81-87

S04

MEASURING INSTRUMENTS AND CLIPPERS 88-92

PROSTHODONTIC 93-95

WAX KNIFE 96

ENDODONTIC INSTRUMENTS 97-104

S05

HANDLES & MOUTH MIRRORS 105-106

CEMENT SPATULAS 107-108

SPATULAS FOR PLASTER AND ALGINATE 109-110

NEEDLE HOLDERS 111-116

DENTAL SYRINGES 117-120

DENTAL TWEEZERS 121-125

RUBBER DAM / PUNCH FORCEPS 126-130

S06

MATRIX RETAINERS / MATRICES 131

CROWN REMOVERS 132-138

RONGEURS 139-142

BONE ELEVATORS & CHISELS 143-144

S07

PLIERS FOR ORTHODONTICS 145-153

IMPRESSION TRAYS 154-157

S08

ARRICULATORS 158-159

SURGICAL HOLLOWARES 160-169

KEY RINGS 170

NEPKIN HOLDERS 171

TABLE OF CONTENTS



ISO 9001: 2016
ISO 13485: 2016

01 SECTION

Extracting Forceps - English Pattern

Mouth Guage

Page 01-37





AD-1001
Fig 8
lower premolars



AD-1002
Fig 13
lower premolars

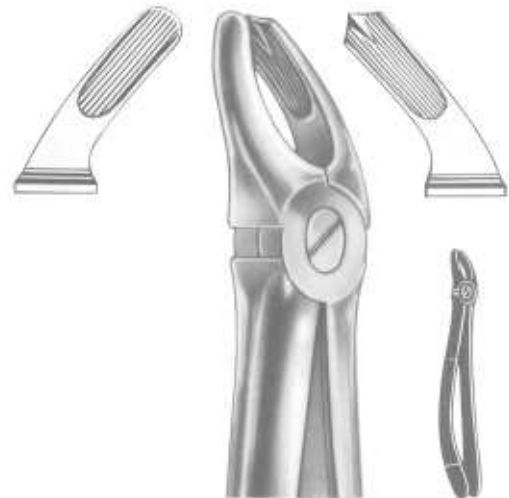

AD-1003
Fig 17
upper molars, right

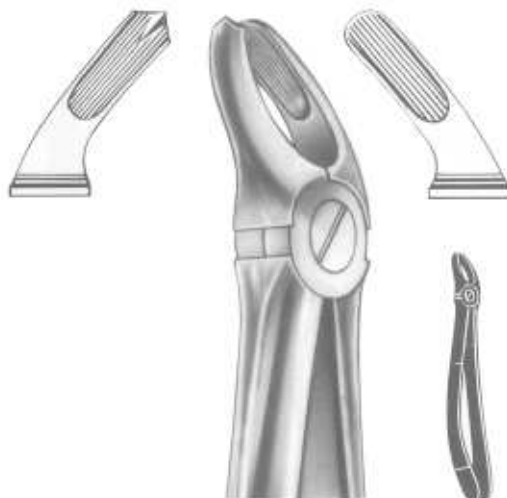

AD-1004
Fig 18
upper molars, left

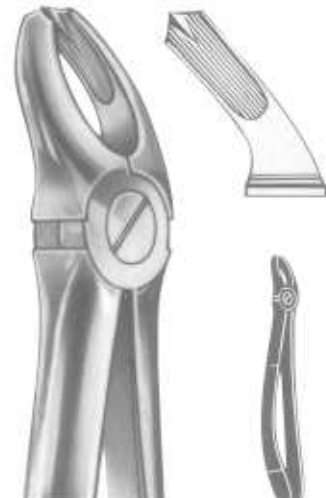

AD-1005
Fig 18 A
upper molars



AD-1006
Fig 19
upper wisdoms

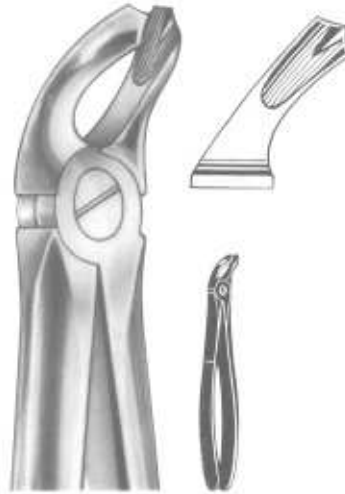

AD-1007
Fig 20
lower wisdoms

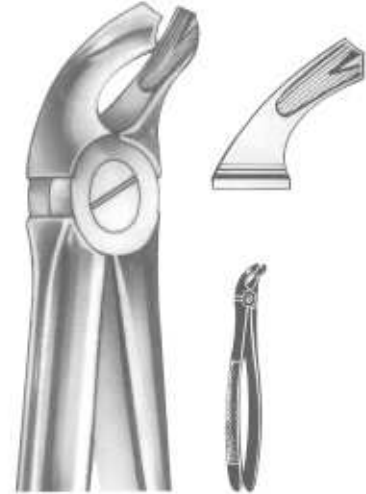

AD-1008
Fig 21
lower molars



AD-1009
Fig 22
lower molars



AD-1010
Fig 22 A
Albrecht
lower molars



AD-1011
Fig 33 A
lower roots



AD-1012
Fig 33 B
lower roots



AD-1013
Fig 33 L
lower roots



AD-1014
Fig 33 L
lower roots



AD-1015
Fig 33 S
lower roots, for children



AD-1016
Fig 44
upper roots



AD-1017
Fig 45
lower roots

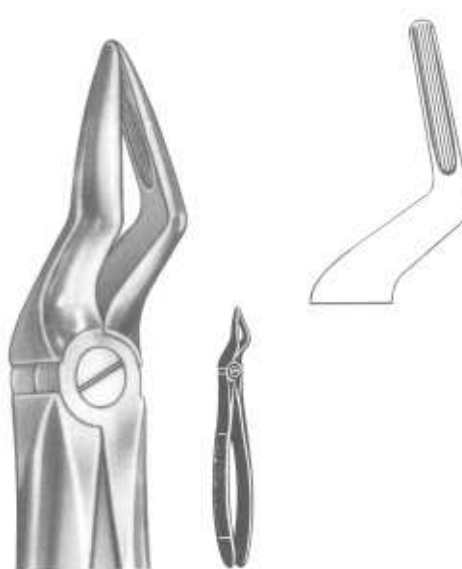

AD-1018
Fig 12
upper roots



AD-1019
Fig 51 A
upper roots

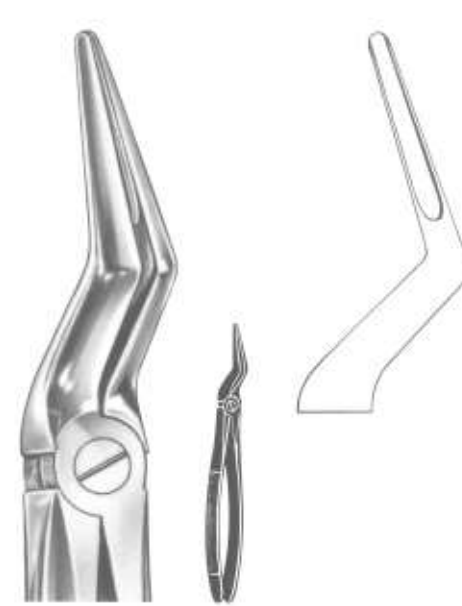

AD-1020
Fig 51 L
upper roots





**Relax
AD-1021**
Fig 51
upper roots



**Relax
AD-1022**
Fig 51 A
upper roots



**Relax
AD-1023**
Fig 51 L
upper roots

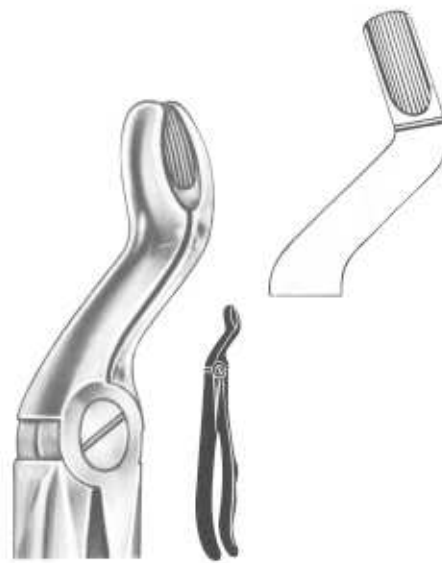

**Relax
AD-1024**
Fig 67
upper wisdoms

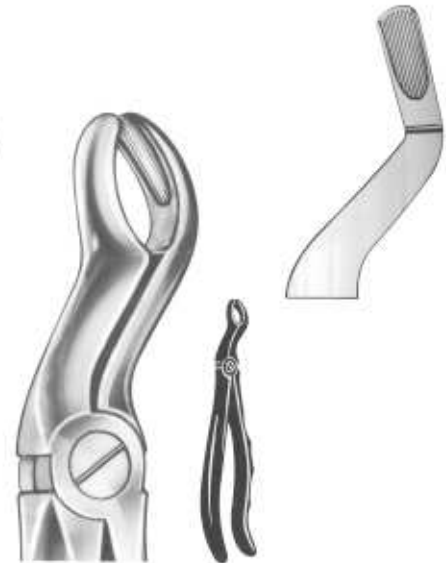

**Relax
AD-1025**
Fig 67 A
upper wisdoms



AD-1026
Fig 37
Upper incisors



WITH SERRATED
TIPS

AD-1027
Fig 39
Upper molars

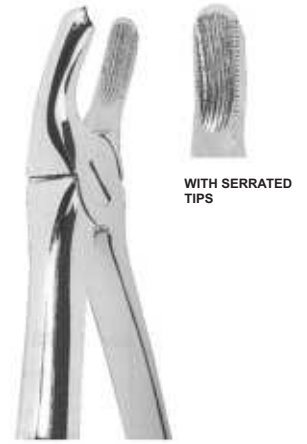

WITH SERRATED
TIPS

AD-1028
Fig 39 R
Upper molars, right

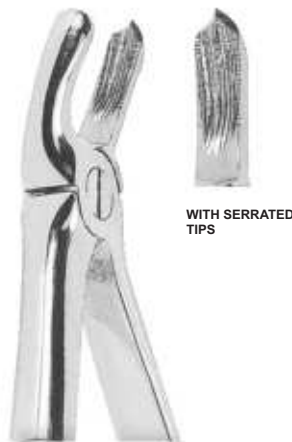

WITH SERRATED
TIPS

AD-1029
Fig 39 L
Upper molars, left



WITH SERRATED
TIPS

AD-1030
Fig 515
Upper roots





**Klein
AD-1032**
Fig 137
upper incisors



**Klein
AD-1031**
Fig 6
lower molars



**Klein
AD-1033**
Fig 5
lower incisors

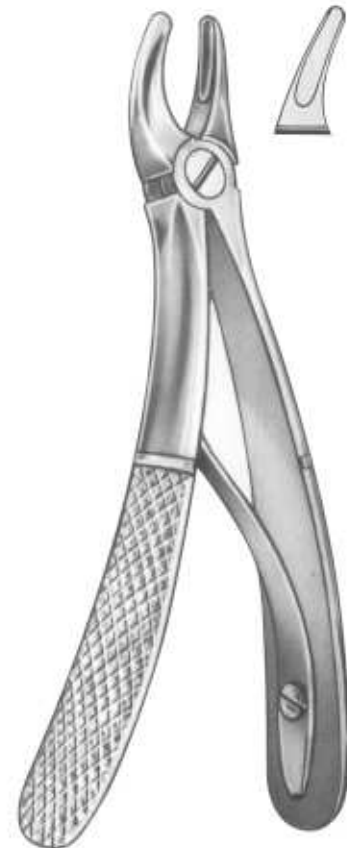

**Klein
AD-1034**
Fig 139
upper premolars



AD-1035
Fig 43 A
Fractured or decayed
upper teeth



AD-1036
Fig 44
Upper roots



AD-1037
Fig 45
Lower roots

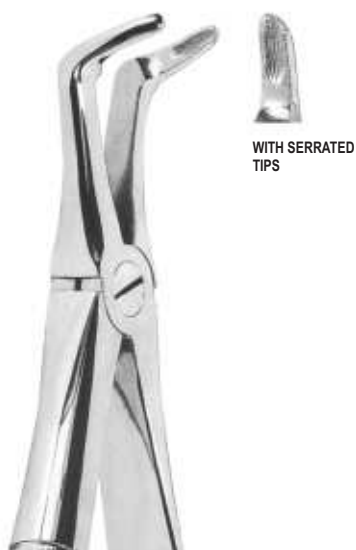

AD-1038
Fig 46
Lower roots



AD-1039
Fig 46 L
Lower roots





AD-1040
Fig 48
Upper roots



AD-1041
Fig 51
Upper roots



AD-1042
Fig 49
Upper roots



AD-1043
Fig 51 L
Upper roots



AD-1044
Fig 51 A
Upper roots





AD-1045
Fig 51 LX
Upper roots



AD-1046
Fig 52
Upper roots and
canines



AD-1047
Fig 54
For separating
upper molars



AD-1048
Fig 55
For separating
upper molars



AD-1049
Fig 56
For separating
lower molars



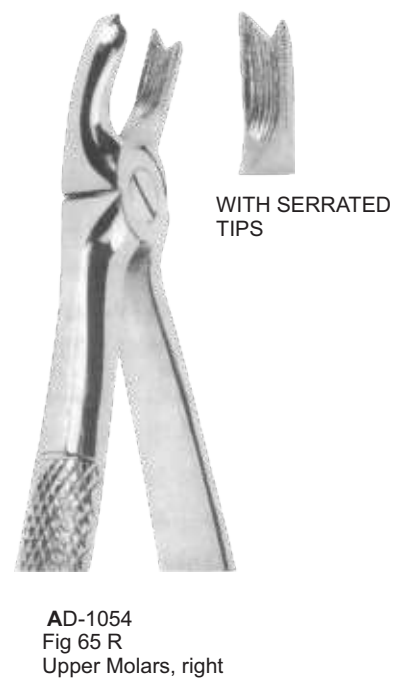



AD-1055
Fig 66 L
Upper molars, left



AD-1056
Fig 66 R
Upper molars, right



WITH SERRATED
TIPS



AD-1057
Fig 67
Upper third molars



WITH SERRATED
TIPS



AD-1058
Fig 67 A
Upper third molars



WITH SERRATED
TIPS



AD-1059
Fig 68
Lower roots



WITH SERRATED
TIPS





AD-1060
Fig 67½ L
Upper third molars, left



AD-1061
Fig 67½ R
Upper third molars, right



AD-1062
Fig 73
Lower molars



AD-1063
Fig 74
Lower roots



AD-1064
Fig 74 M
Lower roots





AD-1065
Fig 74 N
Lower roots



AD-1066
Fig 75
Lower canines and
premolars



AD-1067
Fig 79
Lower third molars

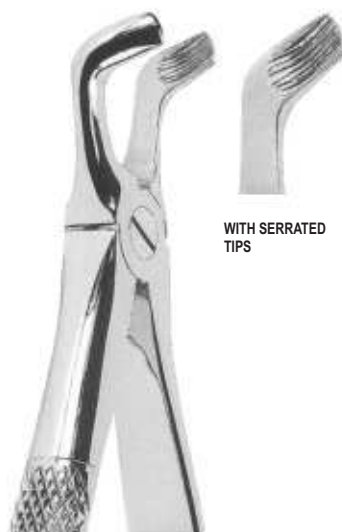

AD-1068
Fig 79 A
Lower third molars

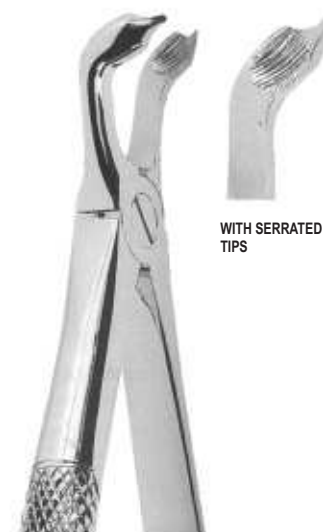

AD-1069
Fig 79 C
Lower third molars





AD-1070
Fig 86 W
Lower third molars



AD-1071
Fig 86½ L
Lower third molars, left



AD-1072
Fig 86½ R
Lower third molars, right



AD-1073
Fig 86 C
Lower molars



AD-1074
Fig 87
Lower decayed molars
or broken-down crowns



WITH SERRATED
TIPS

AD-1075
Fig 89
Upper molars, right



WITH SERRATED
TIPS

AD-1076
Fig 90
Upper molars, left

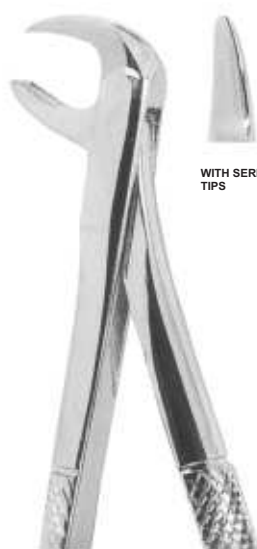

WITH SERRATED
TIPS

AD-1077
Fig 99
Broken-down lower molars

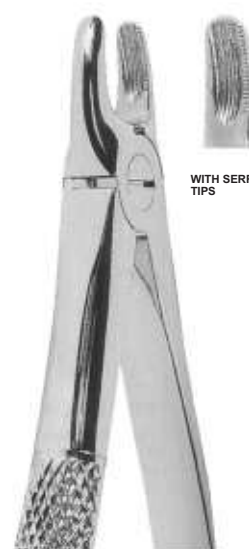

WITH SERRATED
TIPS

AD-1078
Fig 107
Upper canines





AD-1079
Fig 121
Upper third molars



AD-1080
Fig 145
Lower roots



AD-1081
Fig 151½
Upper roots



AD-1082
Fig 166
Universal extracting forceps for
upper teeth, in particular molars
and premolars



AD-1083
Fig 167
Universal extracting forceps for
lower teeth, in particular molars
and premolars



AD-1084
Fig 168
Upper canines



AD-1085
Fig 169
Lower canines



AD-1086
Fig 346
Lower roots

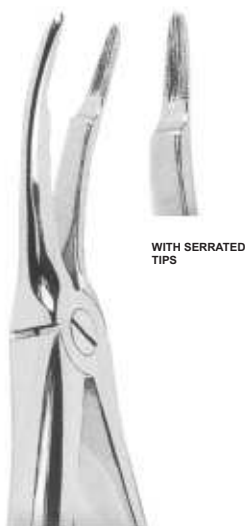

AD-1087
Fig 349
Upper roots



AD-1088
Fig 359
Lower roots





AD-1089
Fig 1
Universal extracting forcep for
upper incisors and canines



AD-1090
Fig 2
Upper molars



AD-1091
Fig 3
Lower incisors, premolar
and roots



AD-1092
Fig 4
Lower molars



AD-1093
Fig 1
Upper incisors
and canines



AD-1094
Fig 2
Upper incisors
and canines

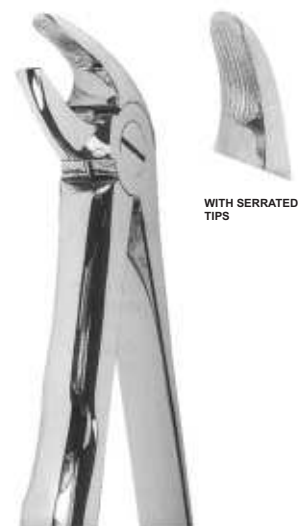

AD-1095
Fig 4
Lower incisors
and canines



AD-1096
Fig 7
Upper premolars



AD-1097
Fig 13
Lower premolars





AD-1098
Fig 17
Upper molars, right



WITH SERRATED
TIPS

AD-1099
Fig 18
Upper molars, left



WITH SERRATED
TIPS

AD-1100
Fig 21
Lower molars



WITH SERRATED
TIPS

AD-1101
Fig 22
Lower molars



WITH SERRATED
TIPS

AD-1102
Fig 33
Lower roots



AD-1103
Fig 45
Lower roots



AD-1104
Fig 51 A
Upper roots

WITH SERRATED
TIPS



AD-1105
Fig 67 A
Upper third
molars

WITH SERRATED
TIPS



AD-1106
Fig 74
Lower roots

WITH SERRATED
TIPS

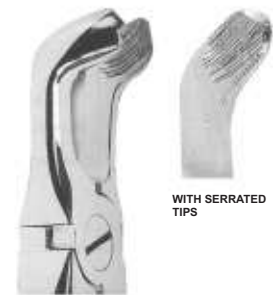

AD-1107
Fig 79
Lower third
molars

WITH SERRATED
TIPS



AD-1108
Fig 86 C
Lower molars

WITH SERRATED
TIPS



AD-1109
Fig 359
Lower roots

WITH SERRATED
TIPS





WITH SERRATED
TIPS

AD-1110
Fig 89
Upper molars, right



WITH SERRATED
TIPS

AD-1111
Fig 90
Upper molars, left

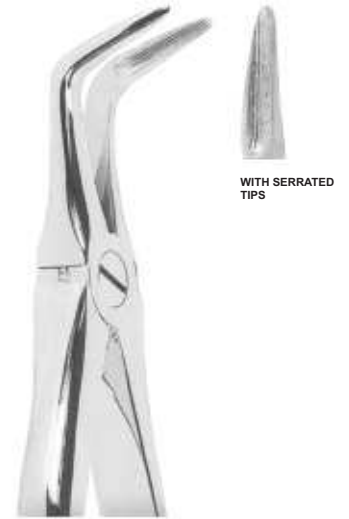

WITH SERRATED
TIPS

AD-1112
Fig 145
Lower roots



WITH SERRATED
TIPS

AD-1113
Fig 151 ½
Upper roots

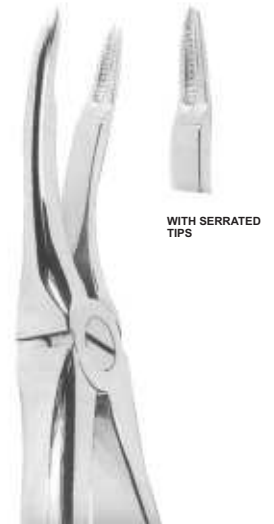

WITH SERRATED
TIPS

AD-1114
Fig 349
Upper roots



AD-1115
Fig 5
Lower third molars



AD-1116
Fig 6
Separating forceps



AD-1117
Fig 105
Upper molars



AD-1118
Fig 16
Lower molars



AD-1119
Fig 17
Lower molars





AD-1120
Fig 18 L
Upper molars, left



AD-1121
Fig 18 R
Upper molars, right



AD-1122
Fig 23
Lower molars



AD-1123
Fig 53 R
Upper molars, right



AD-1124
Fig 53 L
Upper molars, left



AD-1125
Fig 65
Upper incisors and roots



AD-1126
Fig 69
Upper and lower roots



AD-1127
Fig 88 R
Upper molars, right



AD-1128
Fig 88 L
Upper molars, left



AD-1129
Fig 101
Deciduous teeth





AD-1130
Fig 150
Upper incisors, premolars, roots



AD-1131
Fig 150 S
Upper teeth (for children)



AD-1132
Fig 151
Upper incisors, premolars, roots



AD-1133
Fig 151S
Lower teeth (for children)



AD-1134
Fig 222
Lower third molars



AD-1135
Fig 1
upper incisors and bicuspid



AD-1136
Fig 1 B
upper roots, anterior



Physick
AD-1137
Fig 5
lower wisdoms



AD-1138
Fig 6
lower molars, splitting forceps



AD-1139
Fig 10 H
upper molars





WITH SERRATED
TIPS

AD-1140
Fig 135
Lower premolars



AD-1141
Fig 225
Lower molars



AD-1142
Fig 305
Upper incisors
and roots



WITH SERRATED
TIPS

AD-1143
Fig 33 S
Lower roots



WITH SERRATED
TIPS

AD-1144
Fig 38
Lower incisors
and canines



AD-1145
Fig 1
Upper incisors



AD-1146
Fig 2
Upper permolars



AD-1147
Fig 3
Upper molars



AD-1148
Fig 4
Upper roots



AD-1149
Fig 5
Lower incisors



AD-1150
Fig 6
Lower molars



AD-1151
Fig 7
Lower roots





AD-1152
Fig 1
Lower roots



AD-1153
Fig 2
Upper roots

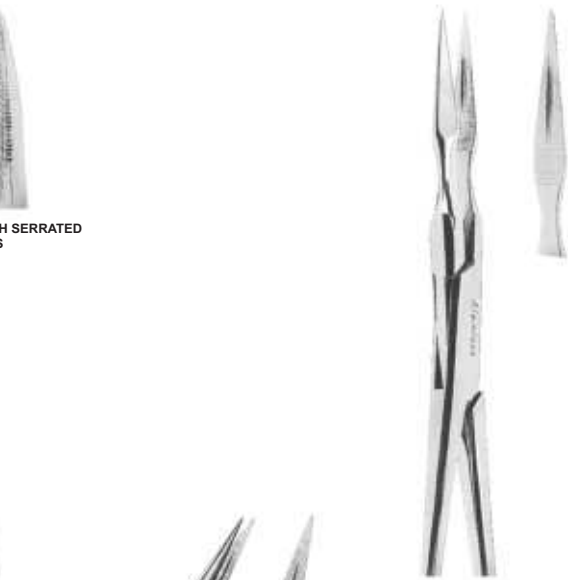

AD-1154
Fig 1
Roots fragments



AD-1155
Fig 2
Roots fragments



Maty Universal Retractor
230mm
AD-101



Columbia
150mm
AD-104

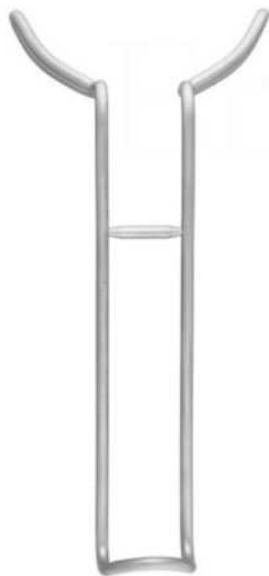

Branemaak
150mm
AD-102



Vestibulum
225mm
AD-103





Jennings Mouth Gag
AD-105 11cm
AD-106 13cm
AD-107 15cm

Oringer Mouth Gag
AD-109

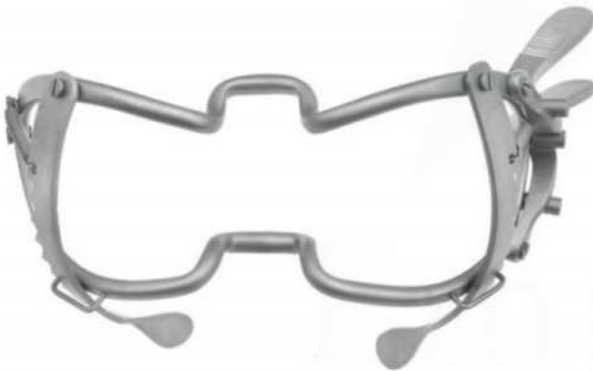

Whitehead
15cm
AD-108

With tongue depressor
15cm
AD-110



Heister
Detachable
AD-111



Heister
With two Screws
AD-112



Molt Mouth Gag
With Silicone coated tips
11cm
AD-113

14cm
AD-114



Molt Mouth Gag
11cm
AD-115

14cm
AD-116



Doyen Collin
With Silicone coated tips
11cm
AD-117

14cm
AD-118



Doyen Jansen
11cm
AD-119

14cm
AD-120





Denhart
13cm / Jaw 16cm
AD-121



Roser Koenig
16cm
AD-122



Roser Koenig
19cm
AD-123



Fergusson Ackland
14.5cm
AD-124



Fergusson Ackland
18cm
AD-125



Davis-boyle Mouth Gag
AD-126

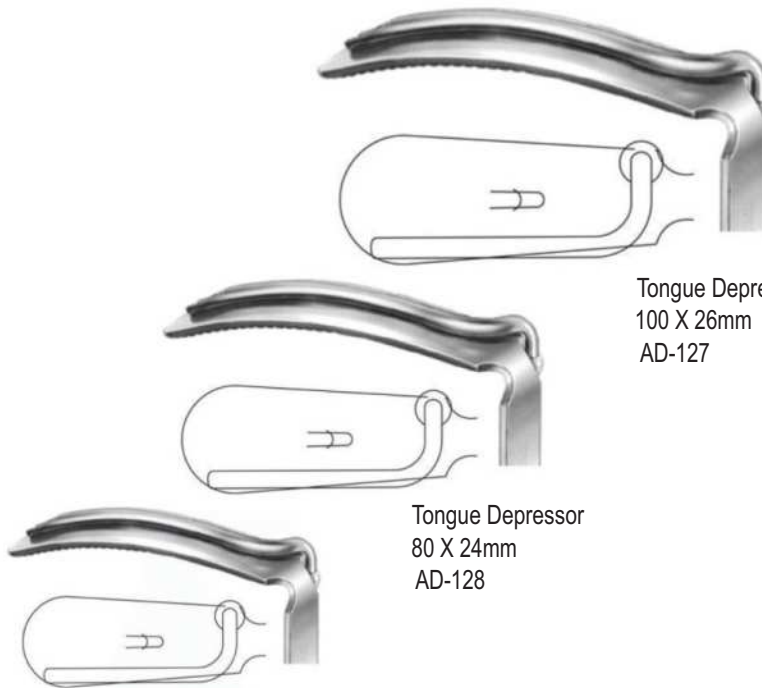

Tongue Depressor
100 X 26mm
AD-127

Tongue Depressor
80 X 24mm
AD-128

Tongue Depressor
65 X 23mm
AD-129



Mcivor Mouth Gag Frame
AD-130



Tongue Depressor
100 X 26mm
AD-133

Tongue Depressor
80 X 25mm
AD-132

Tongue Depressor
75 X 23mm
AD-131



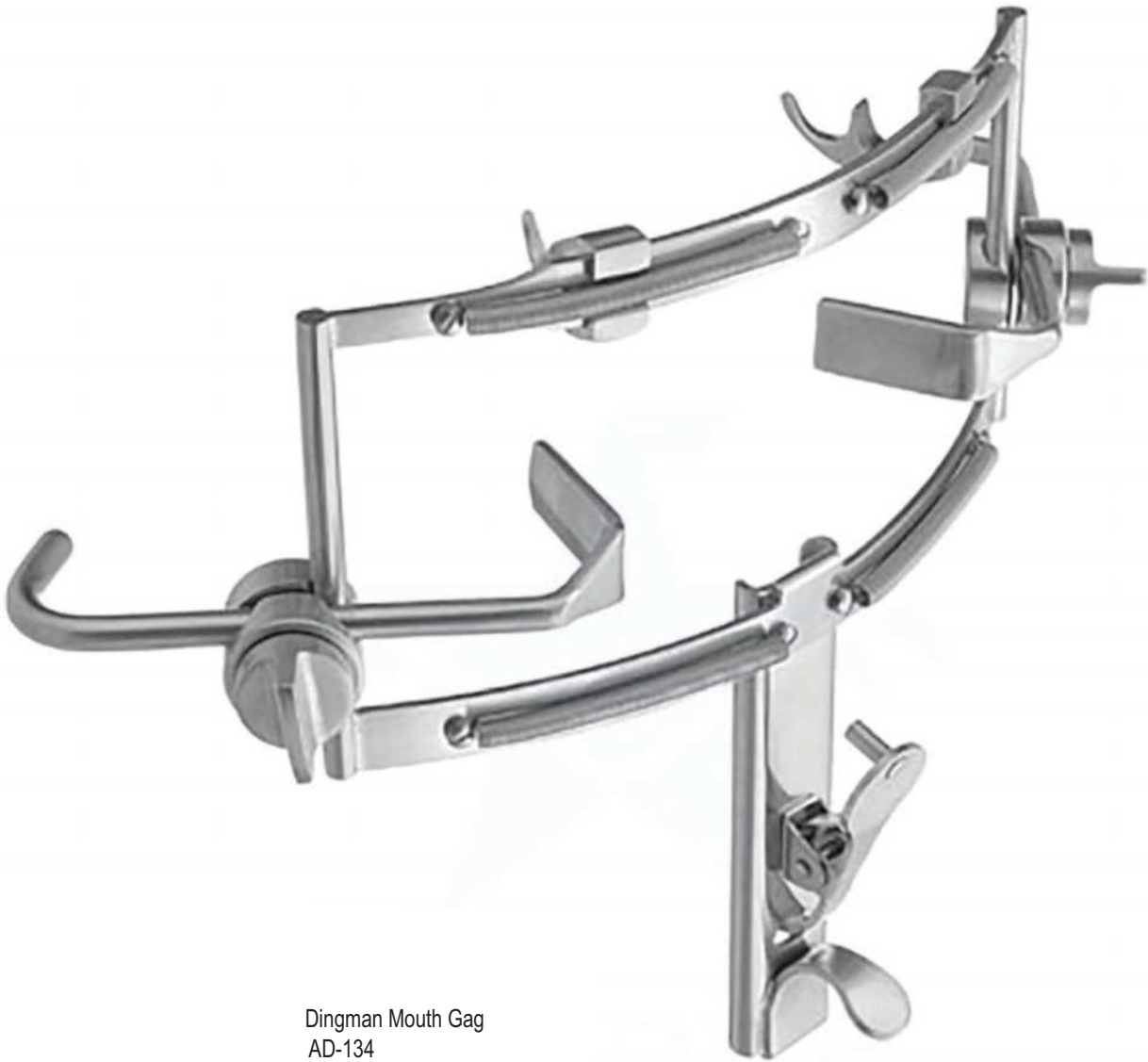

Dingman Mouth Gag
AD-134

02 SECTION

ROOT ELEVATORS, FILLING
INSTRUMENTS & DENTAL PROBES Luxating PDL Root Elevators

Page 38-72





HANDLE TYPES

lower jaw, left side

lower jaw, right side



AD-1200



AD-1201



Root elevator, spiral-shaped, for extremely facilitated extraction of the molars in the lower jaw. The slender, conical points allow deep penetration between tooth and gum. Owing to the hook-shaped working parts, slipping of the elevator is avoided.



Bein



**Bein
AD-1202**
Fig 1



**Bein
AD-1203**
Fig 2



**Bein
AD-1204**
Fig 0



**Bein
AD-1205**
Fig 3



**Bein
AD-1206**
Fig 4



**Bein
AD-1207**
Fig 5



**Bein
AD-1208**
Fig 6





Seldin



**Seldin
AD-1209
Fig 1L**



**Seldin
AD-1210
Fig 1R**



**Seldin
AD-1211
Fig 2**



**Seldin
AD-1212
Fig 3**



**Seldin
AD-1213
Fig 4L**



**Seldin
AD-1214
Fig 4R**



**Cryer
AD-1215
Fig 3**



**Cryer
AD-1216
Fig 4**



**Cryer
AD-1217
Fig 12**



**Cryer
AD-1218
Fig 27**



**Cryer
AD-1219
Fig 28**



**Cryer
AD-1220
Fig 27 S**



**Cryer
AD-1221
Fig 28 S**





Apical



**Apical
AD-1222
Fig 1**



**Apical
AD-1223
Fig 2**



**Apical
AD-1224
Fig 3**



**Apical
AD-1225
Fig 4**



Cryer



Cryer
AD-1226
Fig 1



Cryer
AD-1227
Fig 2



Coupland



Coupland
AD-1228
Fig 1



Coupland
AD-1229
Fig 2



Coupland
AD-1230
Fig 3





AD-1231
Fig 1



AD-1232
Fig 2



AD-1233
Fig 3



**Flohr
AD-1234**
Fig 1

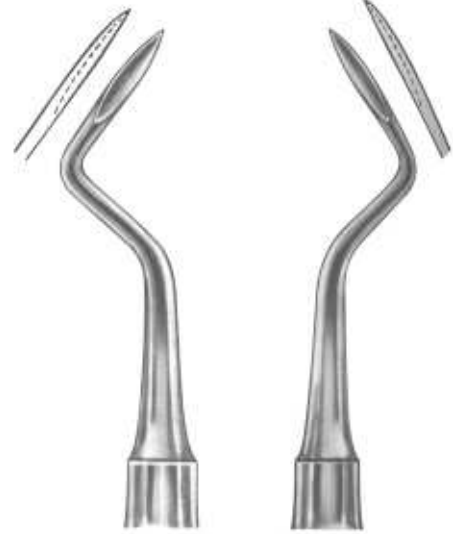

**Flohr
AD-1235**
Fig 2

**Flohr
AD-1236**
Fig 3



**Kopp
AD-1237
Fig 1**



**Kopp
AD-1238
Fig 2**



**Kopp
AD-1243
Fig 1**



**Kopp
AD-1244
Fig 2**



Kopp



**Kopp
AD-1239
Fig 3**



**Kopp
AD-1240
Fig 4**



Kopp



**Kopp
AD-1245
Fig 3**



**Kopp
AD-1246
Fig 4**



**Kopp
AD-1241
Fig 5**



**Kopp
AD-1242
Fig 6**



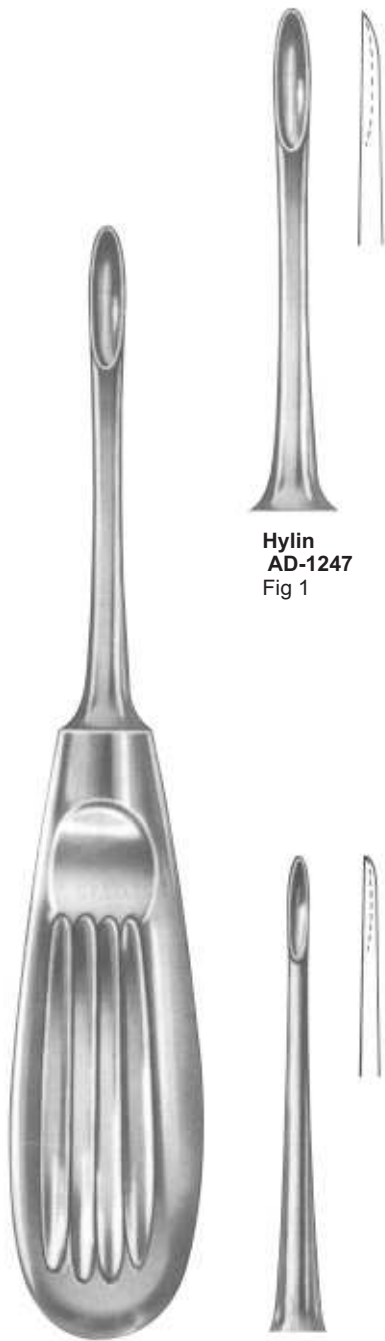

**Hylin
AD-1247
Fig 1**



**Bein
AD-1249
Fig 1**

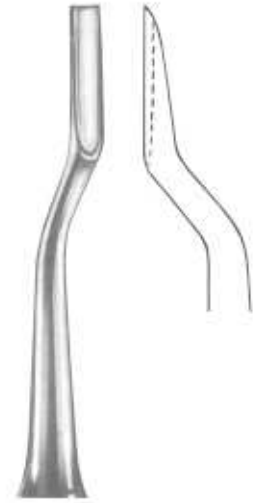

**Bein
AD-1250
Fig 2**



**Hylin
AD-1248
Fig 2**



Bein

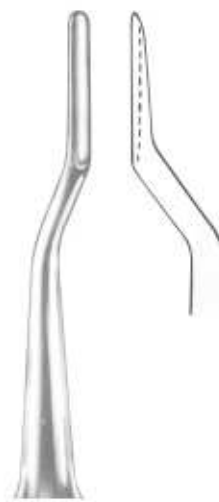

**Bein
AD-1251
Fig 3**



**Bein
AD-1252
Fig 4**



**Warwick-James
AD-1253
Fig 1**



**Warwick-James
AD-1254
Fig 2**



**Warwick-James
AD-1255
Fig 3**



**London Hospital
AD-1256
Fig 1**



**London Hospital
AD-1257
Fig 2**



**London Hospital
AD-1258
Fig 3**



**Ott
AD-1259**



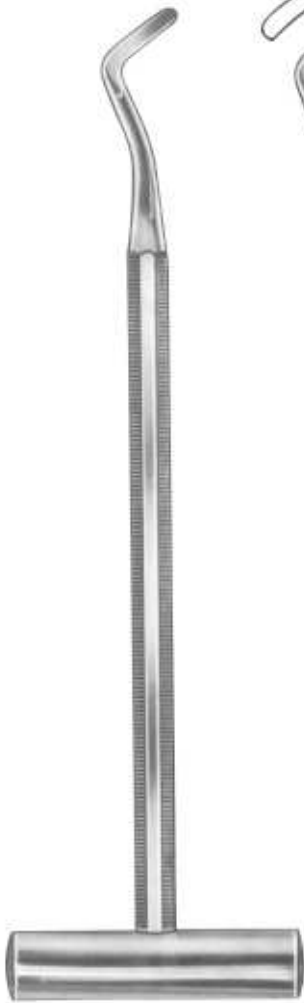

Pott



**Pott
AD-1260
Fig 1**

**Pott
AD-1261
Fig 2**



**AD-1262
Fig 1**



**AD-1263
Fig 2**

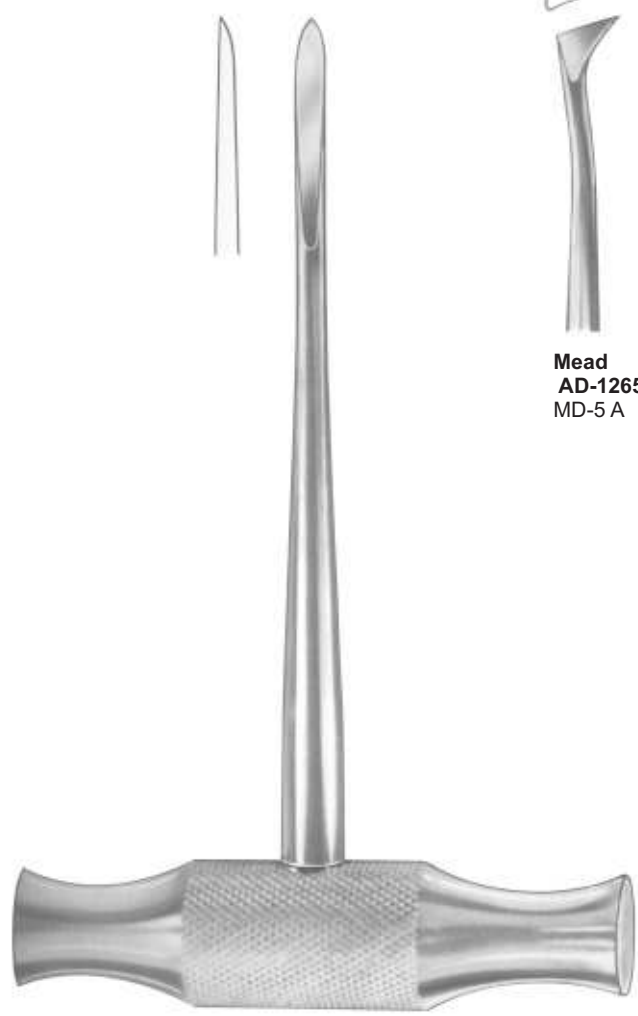

**Mead
AD-1264
MD 1**



**Mead
AD-1265
MD-5 A**



**Mead
AD-1266
MD-6 A**



**Mead
AD-1267
MD-7 A**



**Mead
AD-1268
MD-8**

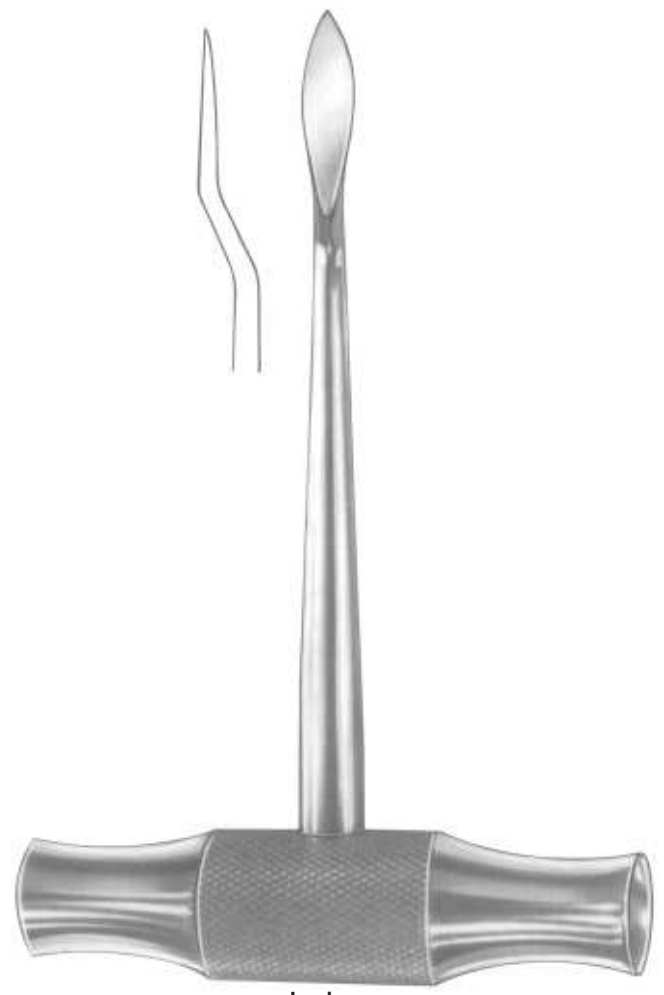
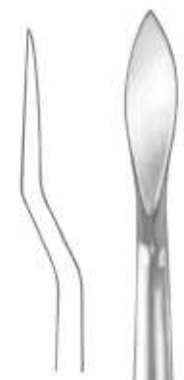

**Lecluse
AD-1269**





**Chompret
AD-1270
Fig 1**



**Chompret
AD-1271
Fig 2**



**Chompret
AD-1272
Fig 3**



**Chompret
AD-1273
Fig 4**



**Apical
AD-1274**



AD-1275
Fig 1



AD-1276
Fig 2



AD-1277
Fig 3



**Heidbrink
AD-1278**
Fig 1



**Heidbrink
AD-1279**
Fig 2



**Heidbrink
AD-1280**
Fig 3





**Winter
AD-1281
Fig 1L**



**Winter
AD-1282
Fig 1R**



**Winter
AD-1283
Fig 2L**



**Winter
AD-1284
Fig 2R**



**Winter
AD-1285
Fig 11 L**



**Winter
AD-1286
Fig 11 R**



**Winter
AD-1287
Fig 12 L**



**Winter
AD-1288
Fig 12 R**

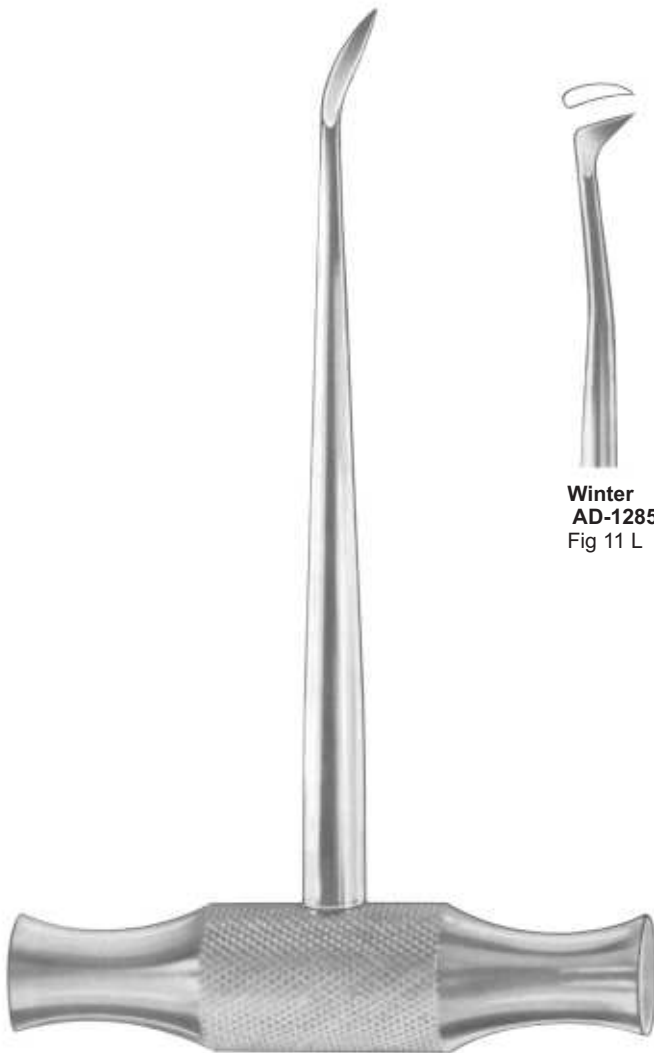

Winter



**Winter
AD-1289
Fig 14 L**



**Winter
1290
Fig 14 R**



**Barry
AD-1291
Fig 1**



**Barry
AD-1292
Fig 2**



**Barry
AD-1293
Fig 3**



**Barry
AD-1294
Fig 4**



Barry



**Barry
AD-1295
Fig 11**



**Barry
AD-1296
Fig 12**



**Barry
AD-1297
Fig 17**



**Barry
AD-1298
Fig 18**



**Cryer
AD-1300
Fig 26**



**Seldin
AD-1301
Fig 27**



**Cryer
AD-1302
Fig 28**



**Cryer
AD-1303
Fig 29**



**Heidbrink
AD-1304
Fig 22**



**Heidbrink
AD-1305
Fig 23**



1299



**Kopp
AD-1307
Fig 31**



**Kopp
AD-1308
Fig 32**



**Kopp
AD-1309
Fig 33**



**Kopp
AD-1310
Fig 34**



**Kopp
AD-1311
Fig 35**



**Kopp
AD-1312
Fig 44**



AD-1306





Heidbrink
AD-1314
Fig 10



Winter
AD-1315
Fig 11



Winter
AD-1316
Fig 12



Barry
AD-1317
Fig 17



Barry
AD-1318
Fig 18



AD-1319
Fig 20



AD-1313

Root Elevators according to Dr. Sader,
with interchangeable working tips



AD-1321



AD-1320



AD-1322





Luxator Periotome
Grey
AD-135



Luxator Periotome
Off White
AD-136



Luxator Periotome
Green
AD-137



Luxator Periotome
Black
AD-138

Luxator Periotome
Dark Blue
AD-139



Luxator Periotome
Light Blue
AD-140



Luxator Periotome
Brown
AD-141



Luxator Periotome
Tan
AD-142





Luxator Periotome
Titanium
AD-143



Luxator Periotome
Titanium
AD-144



Luxator Periotome
Titanium
AD-145



Luxator Periotome
Titanium
AD-146



Pott
130 X 4mm
AD-147



Pott
130 X 3mm
AD-148



Pott
130 X 2mm
AD-149



Mini Elevator serrated E9
3.4mm



Mini Elevator serrated E10
2.5mm



Mini Elevator serrated E11
2.5mm



Mini Elevator serrated E12
2.5mm



Mini Elevator serrated E13
4mm



Mini Elevator serrated E14
4mm



Mini Elevator serrated E15
4mm



Mini Elevator serrated E16
2.5mm



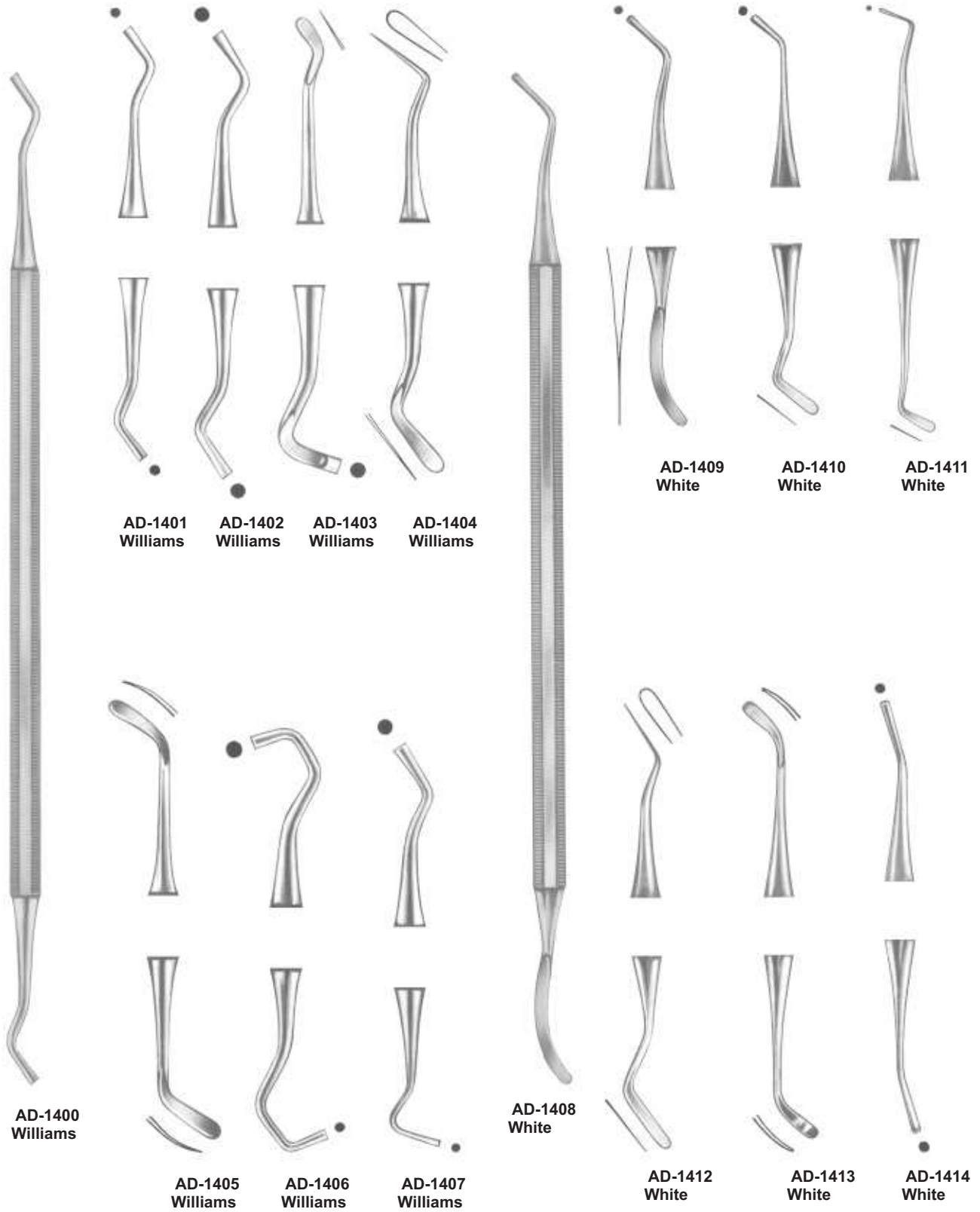

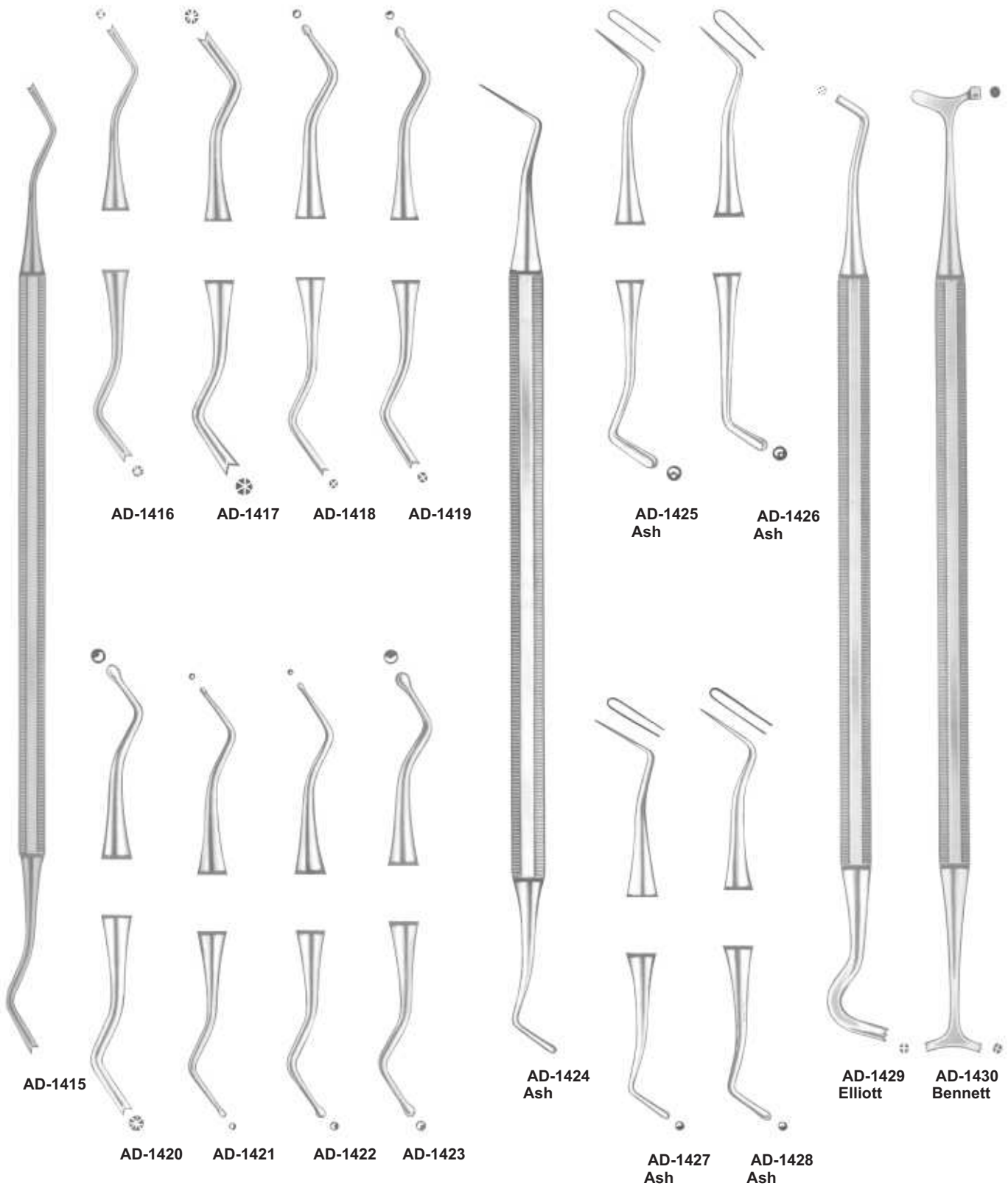

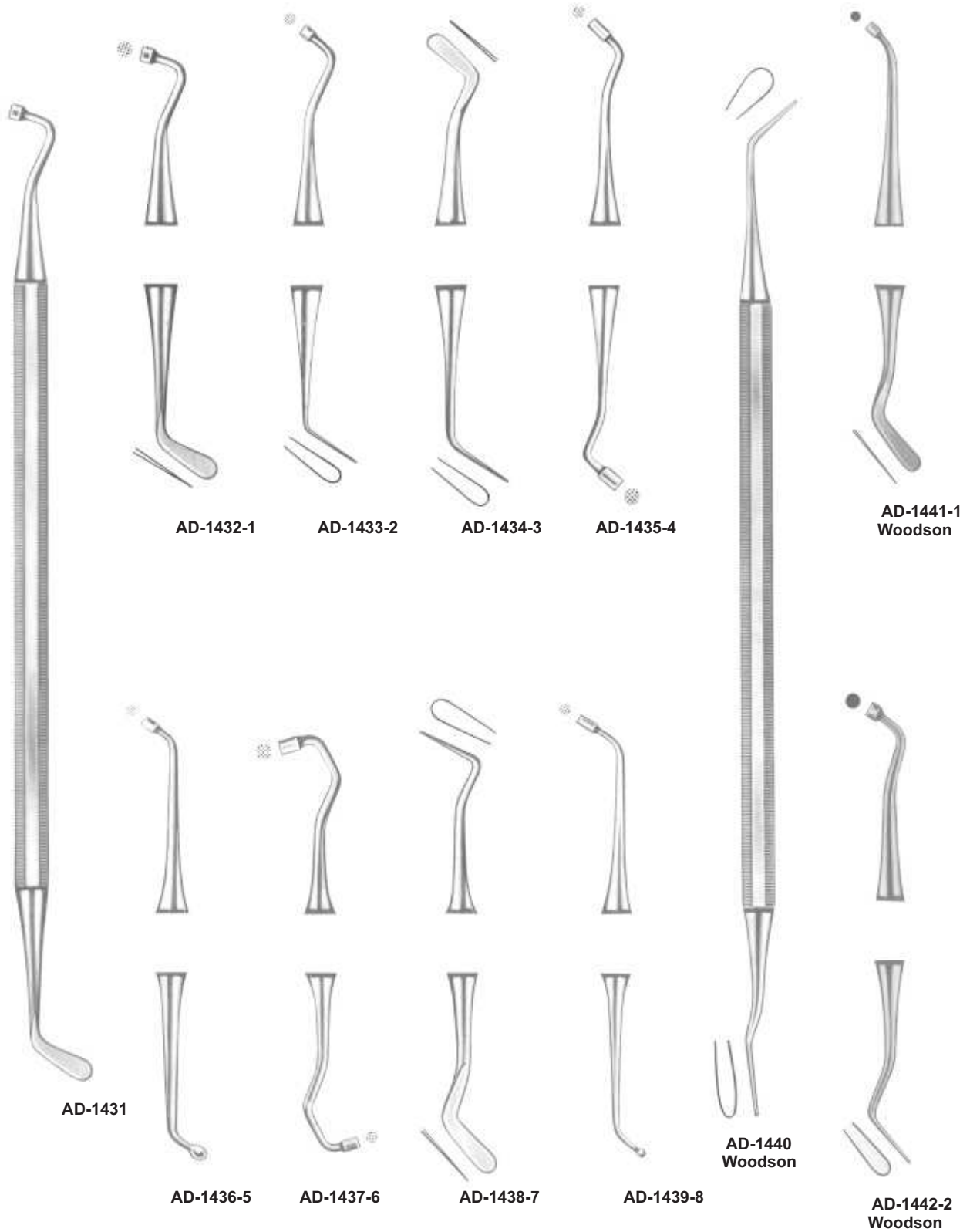



AD-1443
Heidemann
Fig 1



AD-1444
Heidemann
Fig 2



AD-1445
Heidemann
Fig 3



AD-1446



AD-1447
Fig 146



AD-1449
Fig 148



AD-1448
Fig 147



AD-1440
Fig 149



AD-1441
Fig 158



AD-1442
Fig 159

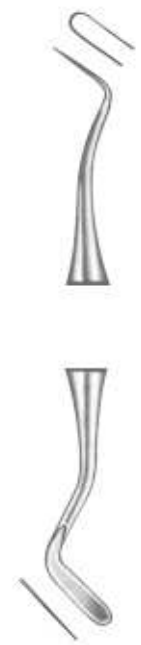

AD-1443
Woodson
Fig 160



AD-1444
Gracey



AD-1445
Gracey
Fig 1



AD-1446
Gracey
Fig 2



AD-1447
Gracey
Fig 3



AD-1448
Gracey
Fig 4



AD-1449
Gracey
Fig 5



AD-1460
Gracey
Fig 6



AD-1461



AD-1462-1
Fig 18



AD-1463-2
Fig 19



AD-1464-3
Fig 20



AD-1465-4
Fig 22



AD-1466-5
Fig 23



AD-1467-6
Fig 25



AD-1468-7
Fig 26



AD-1469-8
Fig 27



With Point Set In



AD-1470



AD-1471-1



AD-1472-2



AD-1473-3



AD-1474-4



AD-1475-5



AD-1476-6



AD-1477-7



AD-1478-8



AD-1479-9



AD-1480-10



AD-1481-11



AD-1482-2
Woodson

Polishing Instruments

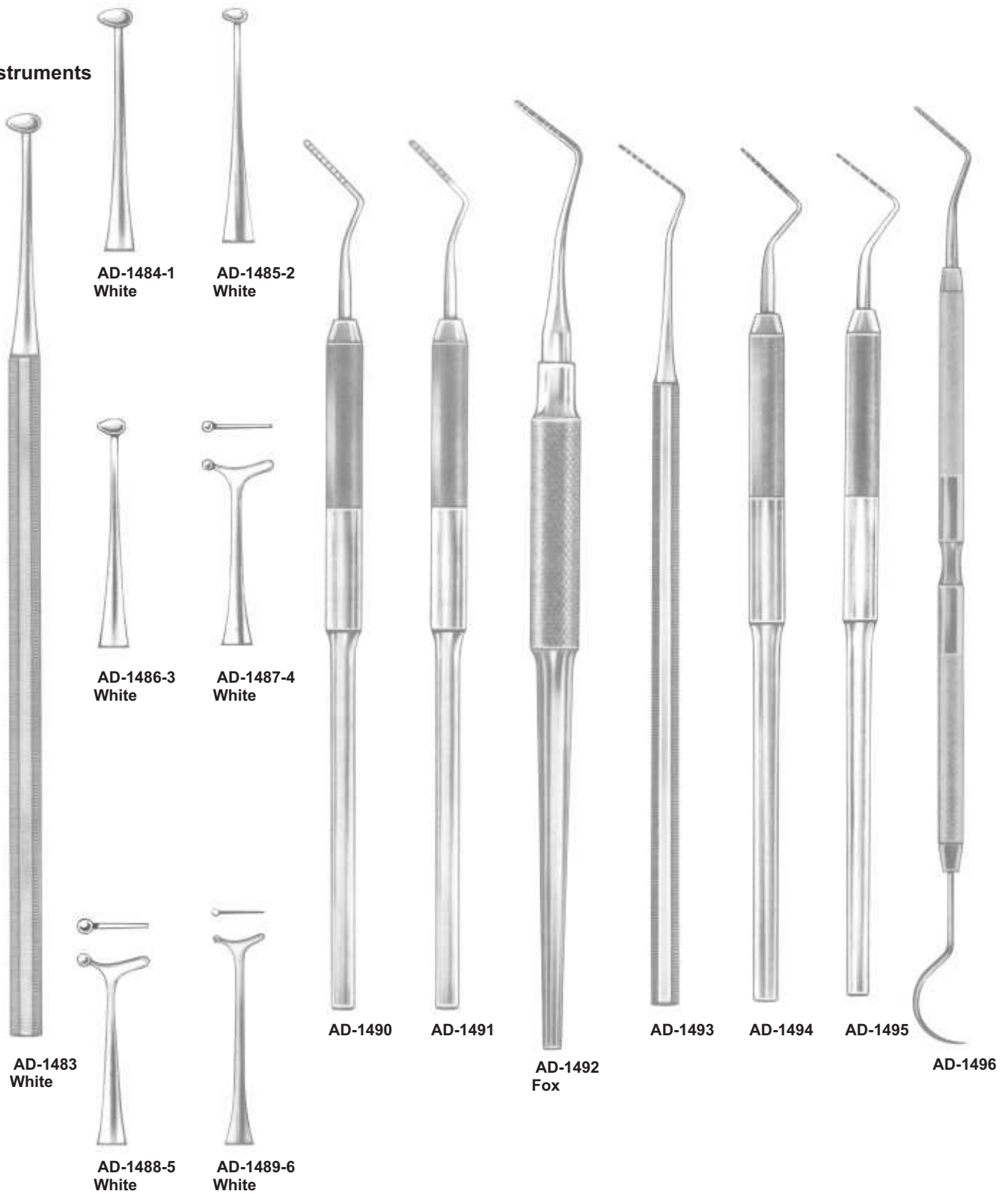



- New marking process.
- Laser system marking.
- No more paint peeling off.
- Permanent marking.
- Antiglare, low depth marking.
- Maximum tip resistance against breaking.

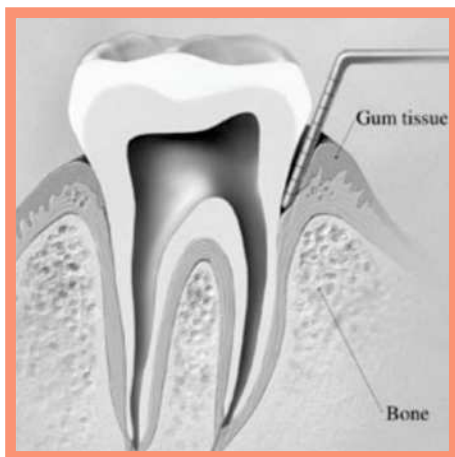

AD-1497
Fig CP-C



AD-1498
Fig CP-11



AD-1499
Fig CP-12



AD-1500
Fig CP-12S
O.M.S



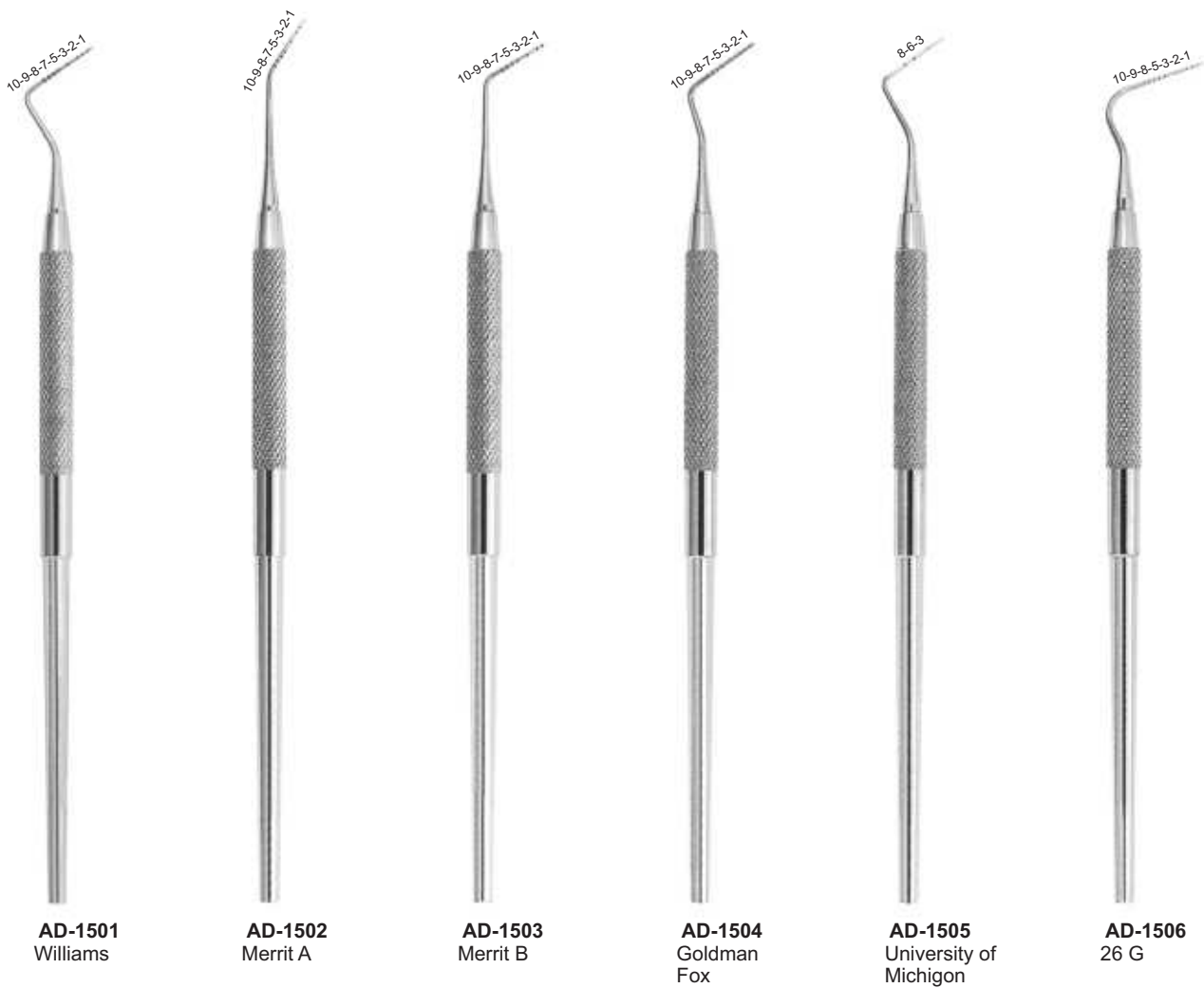
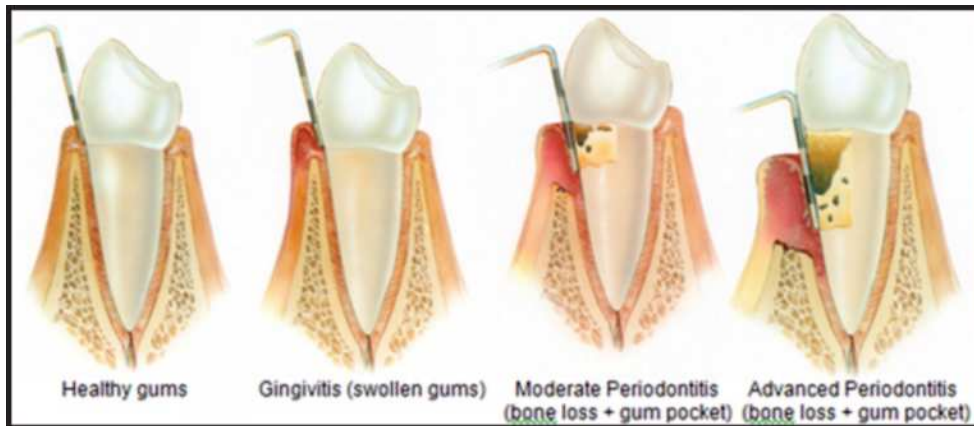

03 SECTION

PERIODONTIA INSTRUMENTS,
MALLETS, CURETTES & SCALERS

Page 73-87



Files

Chisels



AD-1507
Sugarman
Fig. 1S/2S



AD-1508
Sugarman
Fig. 3S/4S



AD-1509
Schluger
Fig. 9/10



AD-1510
Buck
Fig. 11/12



AD-1511
Ochsenein
Fig. 3



AD-1512
Ochsenein
Fig. 4



AD-1513
Rhodes
Back - Action
Fig. 36/37

Files

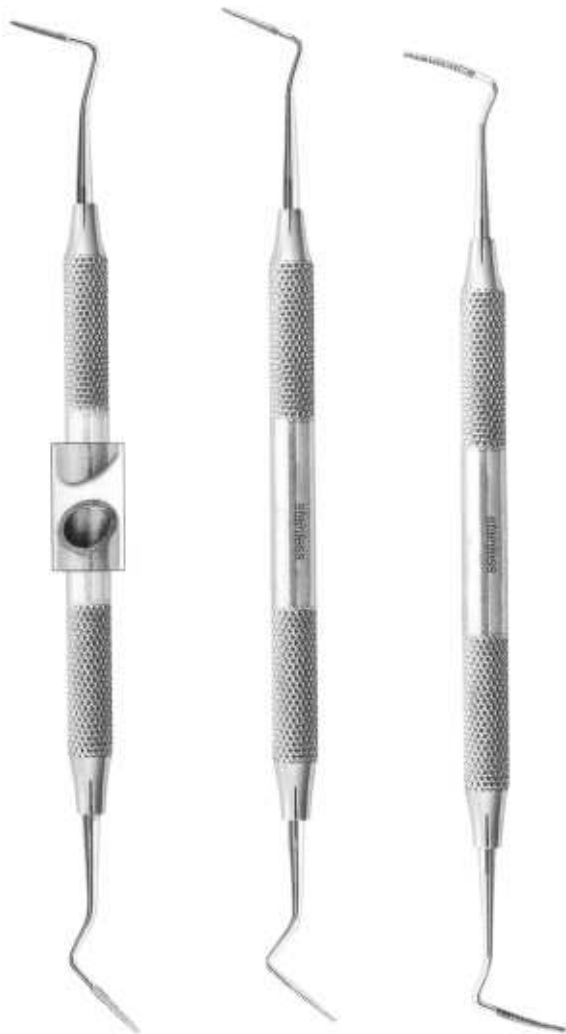

AD-1514
Sugarman
Fig. 1S/2S

AD-1515
Sugarman
Fig. 3S/4S

AD-1516
Schluger
Fig. 9/10



AD-1517
Buck
Fig. 11/12



AD-1518
Ochsenbein
Fig. 3



AD-1519
Ochsenbein
Fig. 4



AD-1520
Rhodes
Back - Action
Fig. 36/37



Gingivectomy knives



AD-1521
Goldman-Fox
Fig. 7



AD-1522
Goldman-Fox
Fig. 8



AD-1523
Goldman-Fox
Fig. 9



AD-1524
Goldman-Fox
Fig. 11



AD-1525
Buck
Fig. 3/4



AD-1526
Buck
Fig. 5/6

Curettes and Scalers



AD-1527
Curette
Fig. HU 1/2



AD-1528
Columbia
Fig. 2R/2L



AD-1529
Columbia
Fig. 4R/4L



AD-1530
Columbia
Fig. 13/14



AD-1531
Fig. 411/412



AD-1532
Fig. 413/414



AD-1533
Zerfing-chisel

Gingivectomy knives

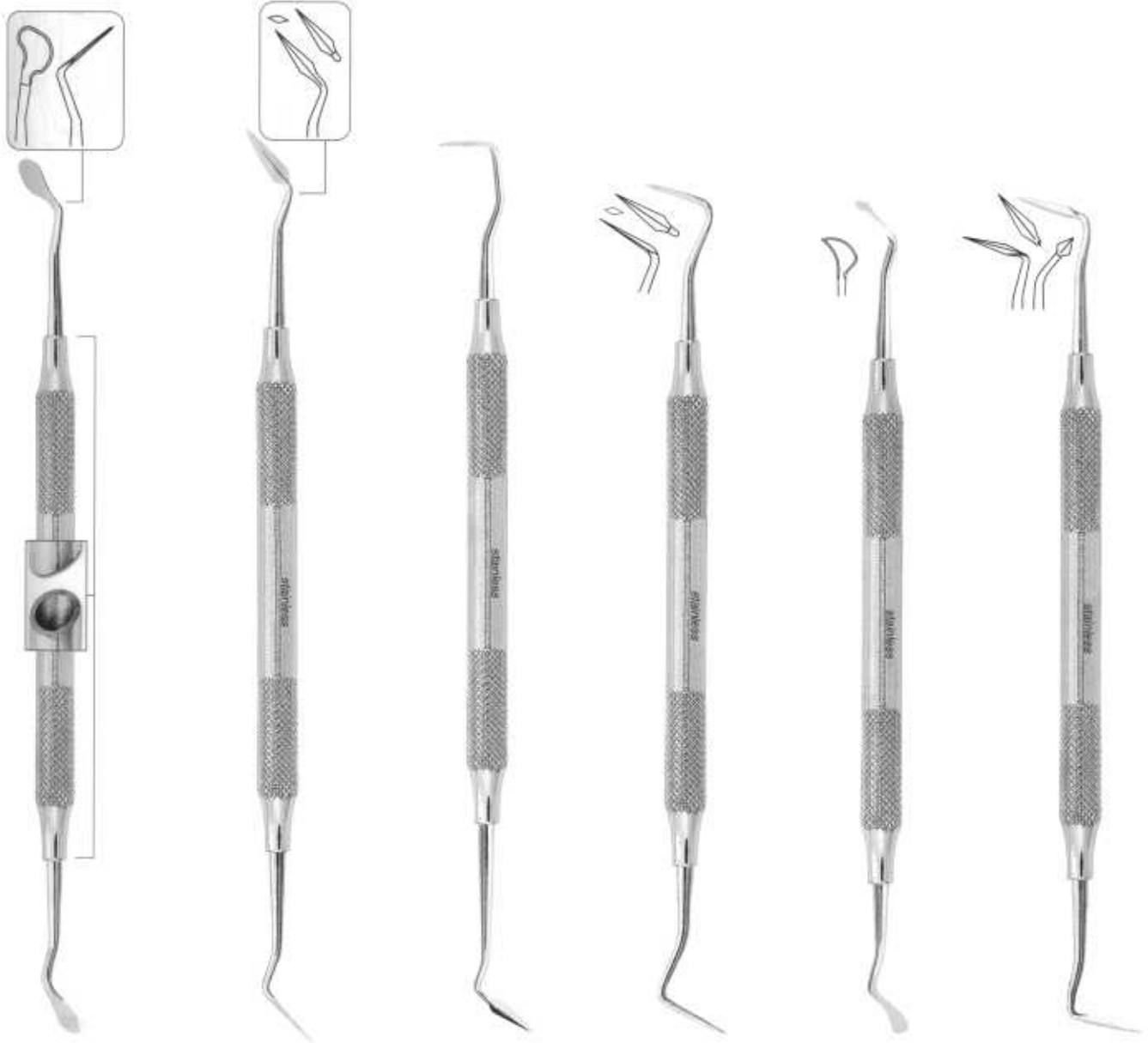

AD-1534
Goldman - Fox
Fig. 7

AD-1535
Goldman - Fox
Fig. 8

AD-1536
Goldman - Fox
Fig. 9

AD-1537
Goldman - Fox
Fig. 11

AD-1538
Buck
Fig. 3/4

AD-1539
Buck
Fig. 5/6

Curettes and Scalers



AD-1540
Curette
Fig. HU 1/2



AD-1541
Columbia
Fig. 2R/2L



AD-1542
Columbia
Fig. 4R/4L



AD-1543
Columbia
Fig. 13/14



AD-1544
Fig. 413/412



AD-1545
Fig. 411/414



AD-1546
Zering-chisel

Bone Chisels and Gouges

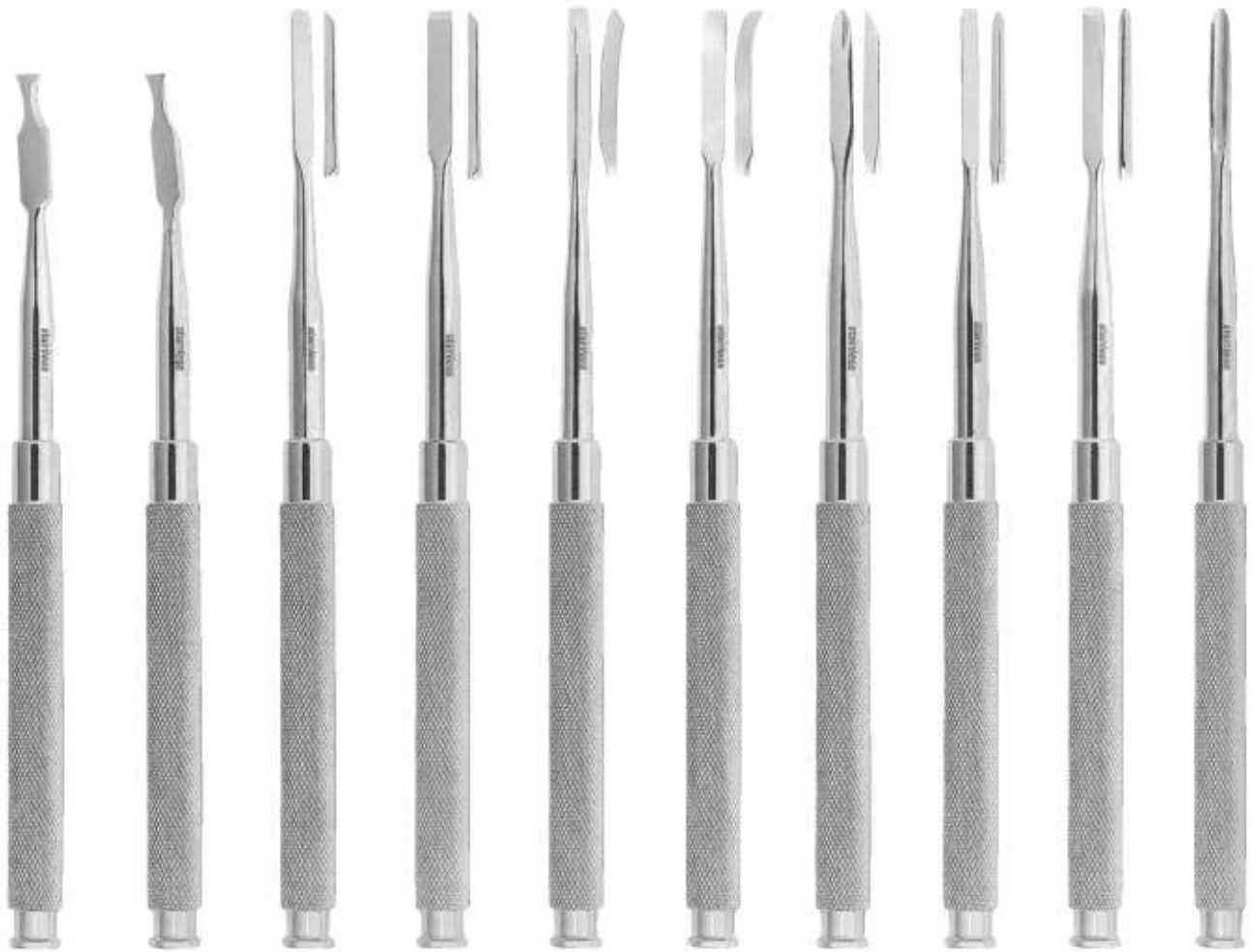

AD-1547
Ochsenbein
Fig. 1

AD-1548
Ochsenbein
Fig. 2

AD-1549
Gardner
Fig. 1

AD-1550
Gardner
Fig. 2

AD-1551
Gardner
Fig. 5

AD-1552
Gardner
Fig. 5R

AD-1553
Gardner
Fig. 6

AD-1554
Wakefield
Fig. 1W

AD-1555
Wakefield
Fig. 2W

AD-1556
Buckley
Fig. 3

Bone Chisels and Gouges

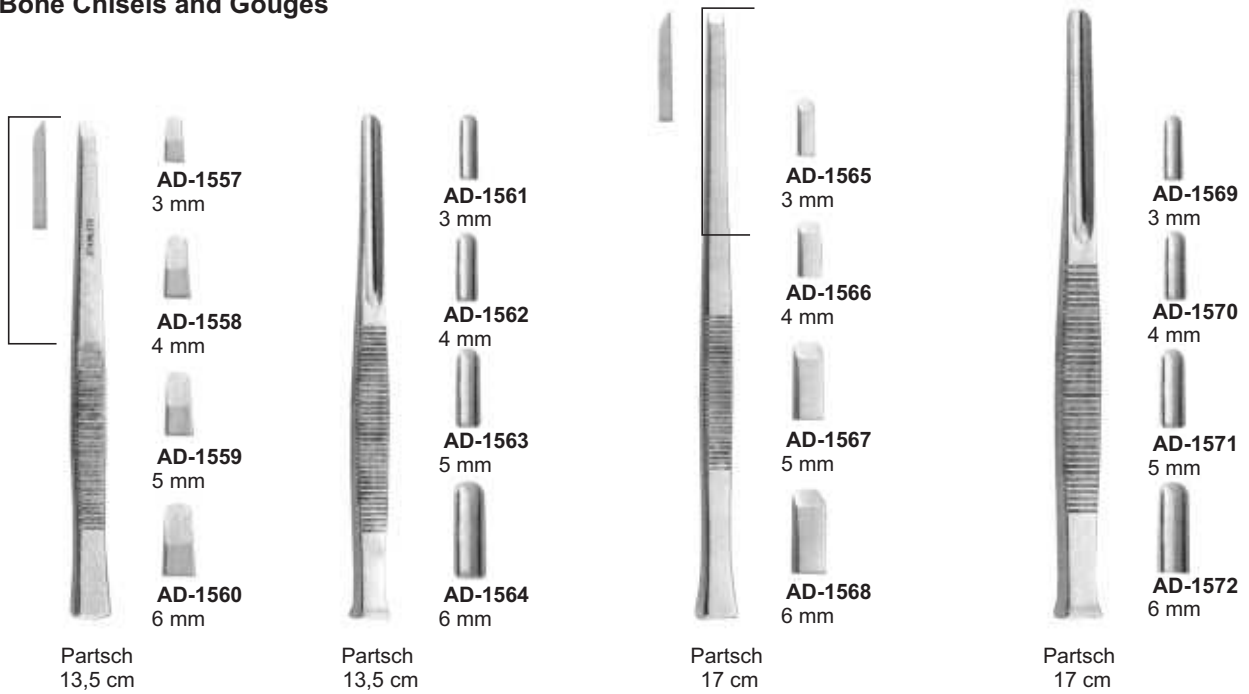

Martelli chirurgici
Mallet

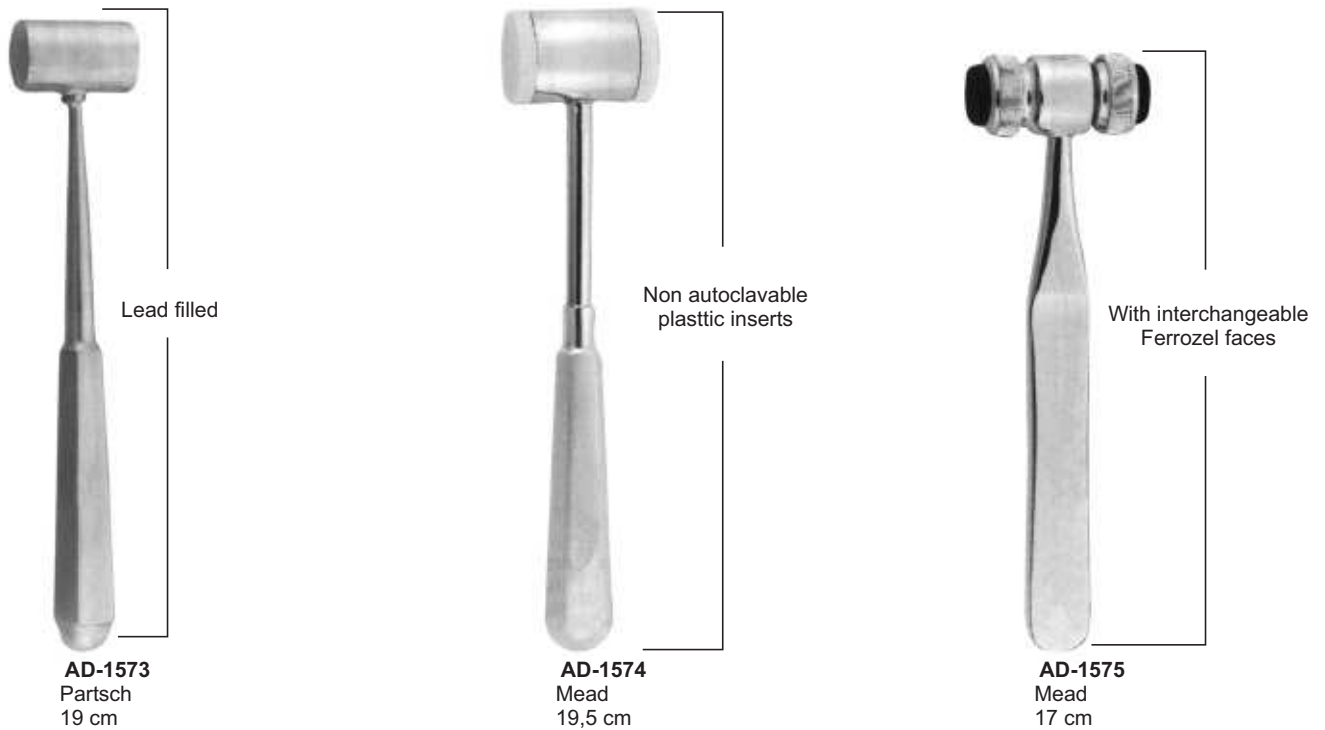

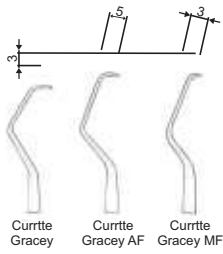

AD-1576
Gracey
Fig. 1/2



AD-1577
Gracey
Fig. 3/4



AD-1578
Gracey
Fig. 5/6



AD-1579
Gracey
Fig. 7/8



AD-1580
Gracey
Fig. 9/10



AD-1581
Gracey
Fig. 11/12



AD-1582
Gracey
Fig. 13/14



AD-1583
Gracey
Mesial Distal
Fig. 11/14



AD-1584
Gracey
Mesial Distal
Fig. 12/13

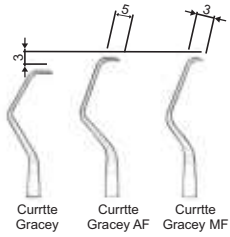

AD-1585
Gracey
AF/type
Fig. 1/2



AD-1586
Gracey
AF/type
Fig. 3/4



AD-1587
Gracey
AF/type
Fig. 5/6



AD-1588
Gracey
AF/type
Fig. 7/8



AD-1589
Gracey
AF/type
Fig. 11/12



AD-1590
Gracey
AF/type
Fig. 13/14



AD-1591
Gracey
AF/type
Fig. 15/16



AD-1593
Gracey
AF/type
Fig. 1/2



AD-1594
Gracey
AF/type
Fig. 3/4



AD-1595
Gracey
AF/type
Fig. 5/6



AD-1596
Gracey
AF/type
Fig. 7/8



AD-1597
Gracey
AF/type
Fig. 11/12



AD-1598
Gracey
AF/type
Fig. 13/14



AD-1599
Gracey
AF/type
Fig. 15/16



AD-1600
Gracey
MF/type
Fig. 1/2



AD-1601
Gracey
MF/type
Fig. 3/4



AD-1602
Gracey
MF/type
Fig. 5/6



AD-1603
Gracey
MF/type
Fig. 7/8



AD-1604
Gracey
MF/type
Fig. 11/12



AD-1605
Gracey
MF/type
Fig. 13/14



AD-1606
Gracey
MF/type
Fig. 15/16

AD-1592
Gracey
AF/type

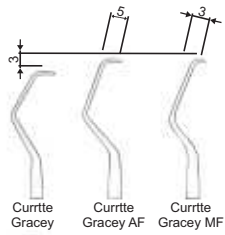

AD-1607
Gracey
MF/type
Fig. ½



AD-1608
Gracey
MF/type
Fig. 3/4



AD-1609
Gracey
MF/type
Fig. 5/6



AD-1610
Gracey
MF/type
Fig. 7/8



AD-1611
Gracey
MF/type
Fig. 11/12



AD-1612
Gracey
MF/type
Fig. 13/14



AD-1613
Gracey
MF/type
Fig. 15/16





AD-1614
Goldman - Fax
Fig. 1



AD-1615
Goldman - Fax
Fig. 2



AD-1617
Goldman - Fax
Fig. 3



AD-1618
Goldman - Fax
Fig. 4



AD-1619
Goldman - Fax
Fig. 21

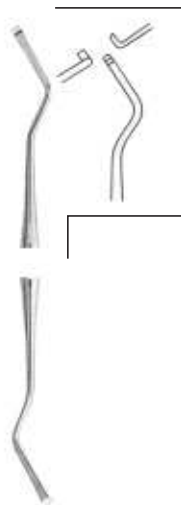

AD-1620
Goldman - Fax
Fig. 5



AD-1621
Mc Call
Fig. 13S/14S



AD-1622
Younger-Good
Fig. 7/8

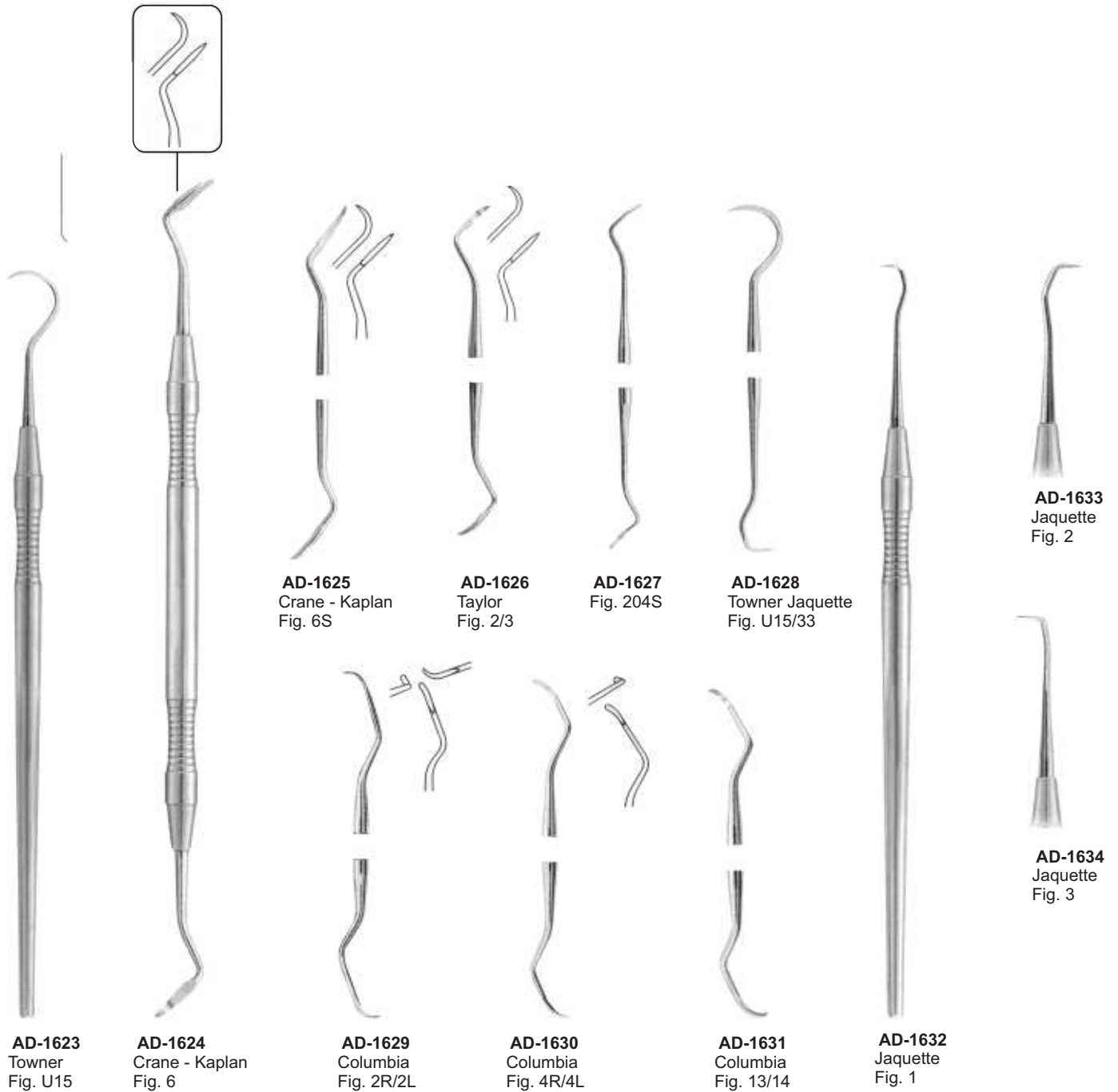



AD-1635
Hemingway
Fig. 1



AD-1636
Hemingway
Fig. 2



AD-1637
Hemingway
Fig. 3



AD-1638
Lucas
Fig. 85



AD-1639
Lucas
Fig. 86



AD-1640
Lucas
Fig. 87

04 SECTION

MODELLING INSTRUMENTS, WAX KNIVES/PLASTER
DIAGNOSTIC, EXPLORER, ENDODONTIC
INSTRUMENTS, EXCAVATORS

Page 88-104





Measurement Caliper Forceps
Straight, 155mm AD-150
Curved, 155mm AD-151



Measurement Caliper Forceps
Straight, 155mm AD-152
Curved, 155mm AD-153



Gauge Visage Measurement Caliper
Measuring Scale On Both Side 0-25mm
AD-156

Parallel Drilling Guide Pin

By Lightening The Fixing Screw Of This Drilling Guide It Is Being Ensured To Keep The Exact Distance While Setting The Implants

With 2.0mm Drill Hole

AD-154

With 2.5mm Drill Hole

AD-155





Compass Caliper
AD-157



Tweezer Caliper
145mm
AD-158



Iwanson Caliper
For Wax
100mm
AD-159



Iwanson Caliper
For Metal
100mm
AD-160



Castroviejo Caliper
20mm, 90mm
AD-161



Castroviejo Caliper
20mm, 45, 90mm
AD-162

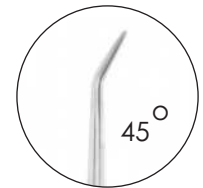

Castroviejo Caliper
20mm, 90mm
AD-165

Castroviejo Caliper
Straight, 180mm
AD-163

Curved, 180mm
AD-164

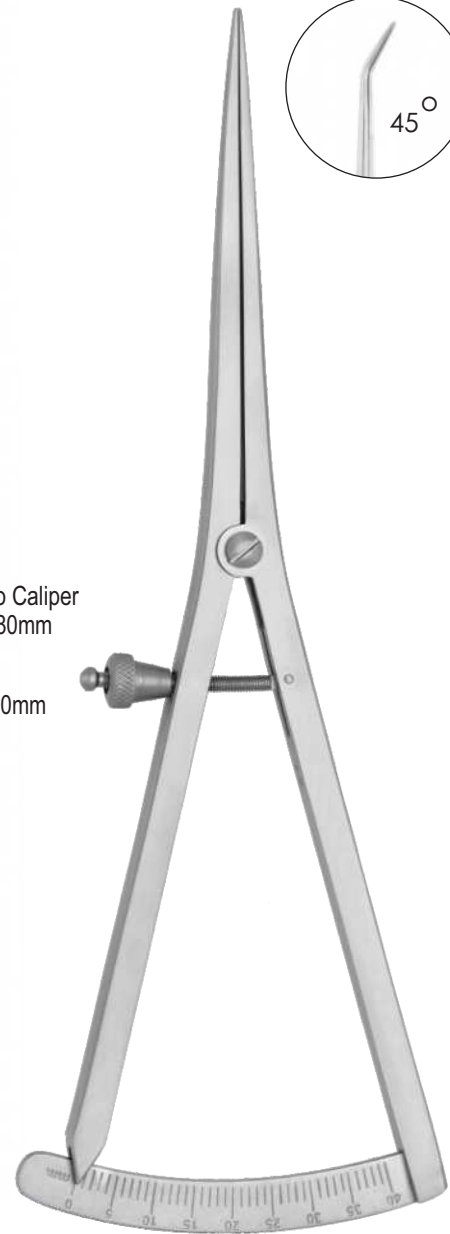



Zuricher Caliper
130mm
AD-166

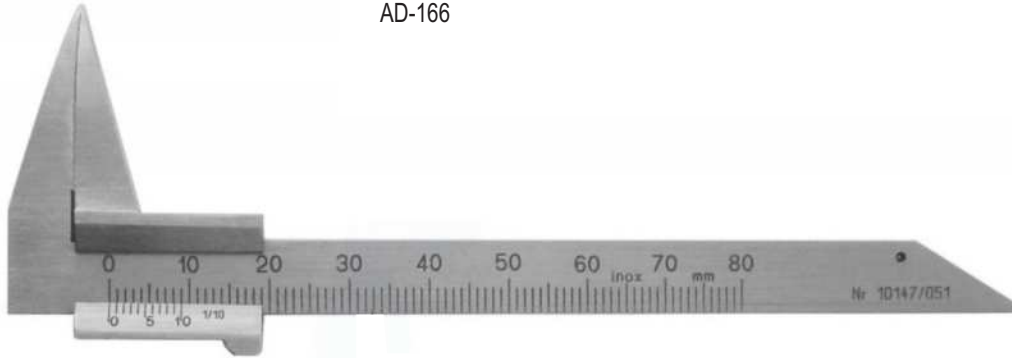

Beerendonk Caliper
130mm
AD-167

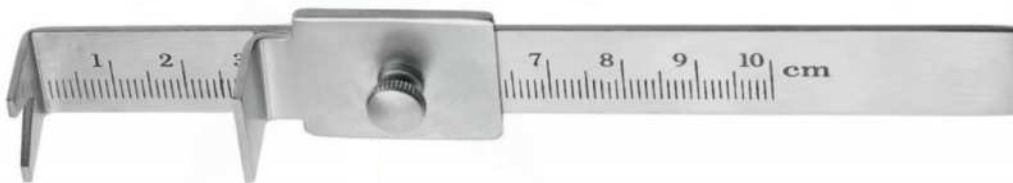

Sliding Caliper
130mm
AD-168

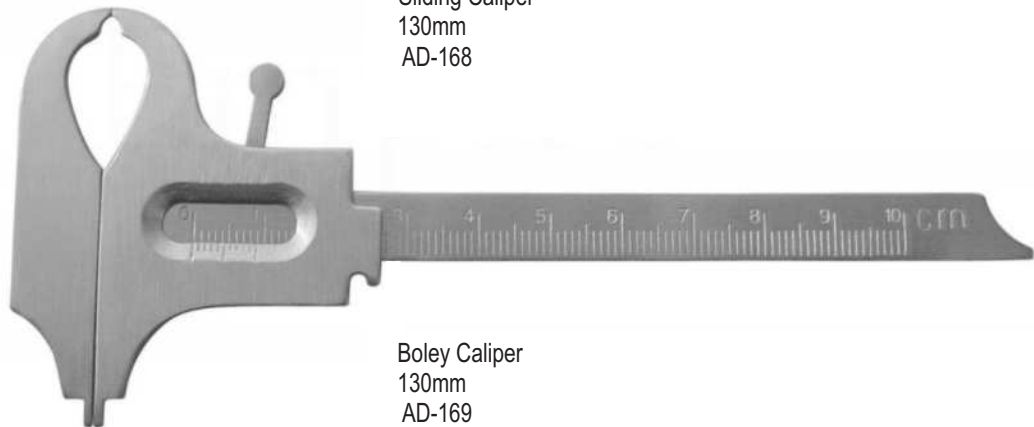

Boley Caliper
130mm
AD-169

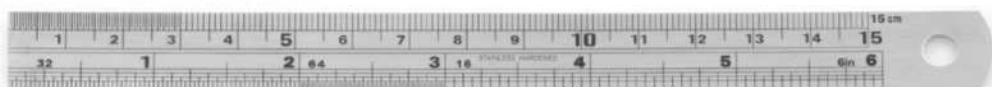

Ruler
150mm
AD-170



Implant Measuring Caliper
Dental Gauge
Straight, 180mm
AD-171



AD-172
Lower Titanium
Milling Part, Rotating



AD-173
Upper Titanium
Milling Part, Rigid

The Bone Morselizer Is Used To Grind Blocks Of Bone Into Smaller Particle Sizes Needed For Grafting Procedures For Small Practices Of Implant Surgery.

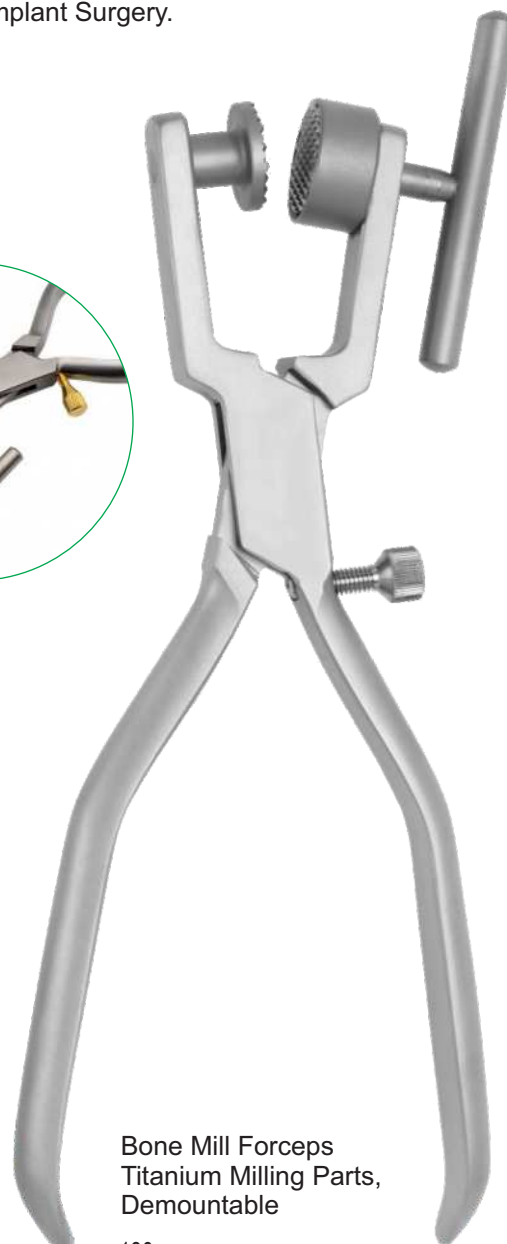

Bone Mill Forceps
Titanium Milling Parts,
Demountable

180mm
AD-174



4422 HYLIN



AD-4441 ZAHLE



AD-4444 LE CRON



AD-4446 HYLIN - LE CRON



AD-4 AD-447



AD-3254 MITCHELL



AD-4470 Silicone knife with cutting ring





AD-4479-1 PK-THOMAS, Aluminium handle
PKT1



AD-4479-2 PK-THOMAS, Aluminium handle
PKT2



AD-4479-3 PK-THOMAS, Aluminium handle
PKT3



AD-4479-4 PK-THOMAS, Aluminium handle
PKT4



AD-4479-5 PK-THOMAS, Aluminium handle
PKT5



AD-4470 FAHNENSTOCK, 13,0 cm



AD-4472 FAHNENSTOCK, 17,0 cm



AD-4476 12,0 cm



AD-4477 17,0 cm



AD-4560
19,0 cm

Spatula for impression
materials very flexible



AD-4558
20,0 cm
Plaster cutting pliers



AD-4542
GRITMAN
16,0 cm
Plaster knife

WAX KNIFE



Fahnenstock
130mm
AD-175



Fahnenstock
170mm
AD-176



Buffalo
130mm
AD-177



170mm
AD-178



Gritman
160mm
AD-179



Gritman
160mm
AD-190



Spatula
Curved, Narrow
AD-191



Spatula
Straight, Wide
AD-192

Spatula
Straight, Narrow
AD-193

Roghe
AD-180



Explorers



AD-1800
Fig 23



AD-1801
Fig 6



AD-1802
Fig 8



AD-1803
Fig 9



AD-1804
Fig 17



AD-1805
Fig 3
Rein



AD-1806
Fig 23/17



AD-1807
Fig 17



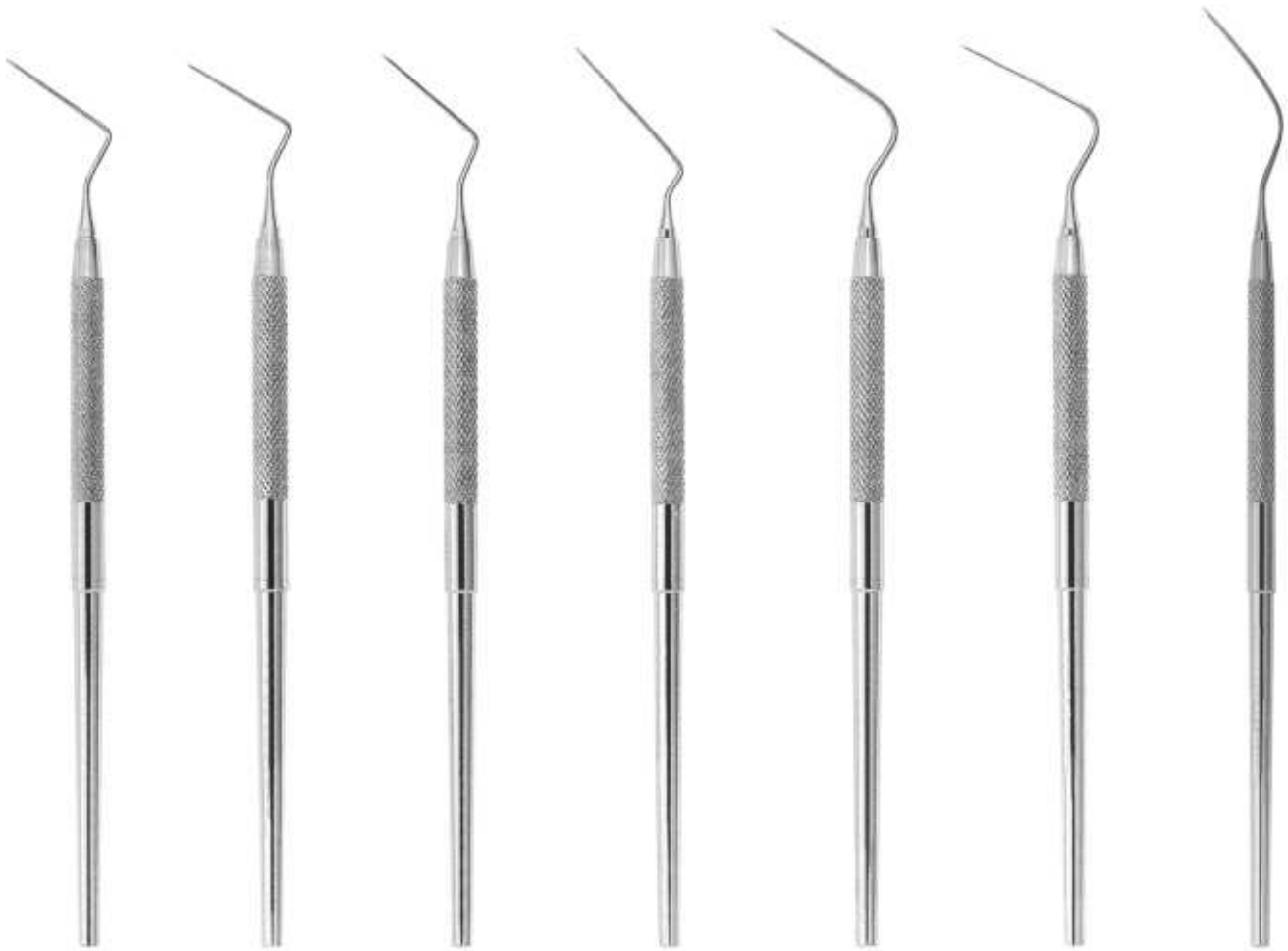

AD-1808
Fig.1
Spreader

AD-1809
Fig.2
Spreader

AD-1810
Fig.3
Spreader

AD-1811
Fig.4
Spreader

AD-1812
Fig.5
Spreader

AD-1813
Fig.6
Spreader

AD-1814
Fig.7
Spreader

Double-Ended Root Canal Explorers Plugger/Spreaders

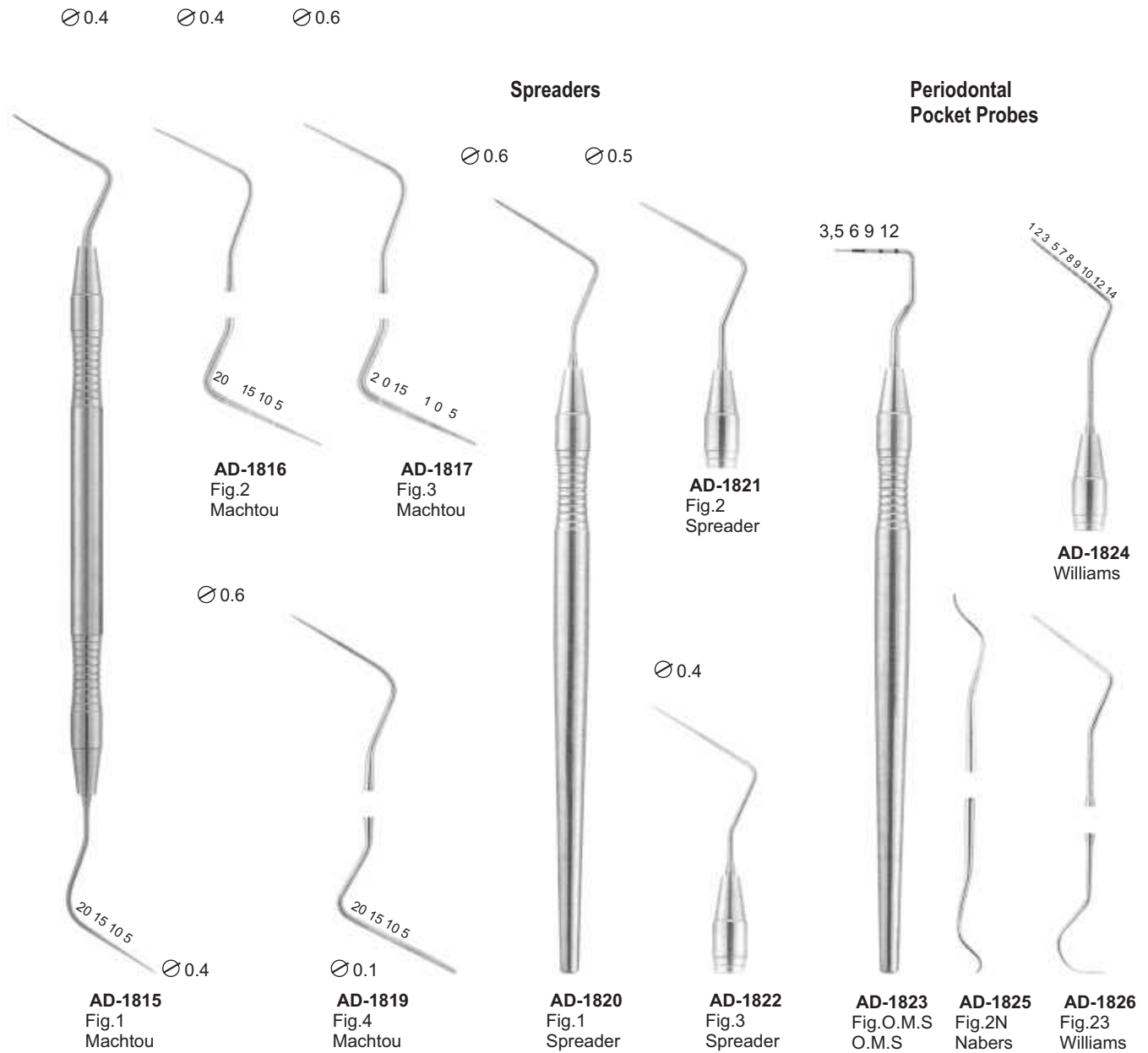

Root-canal pluggers

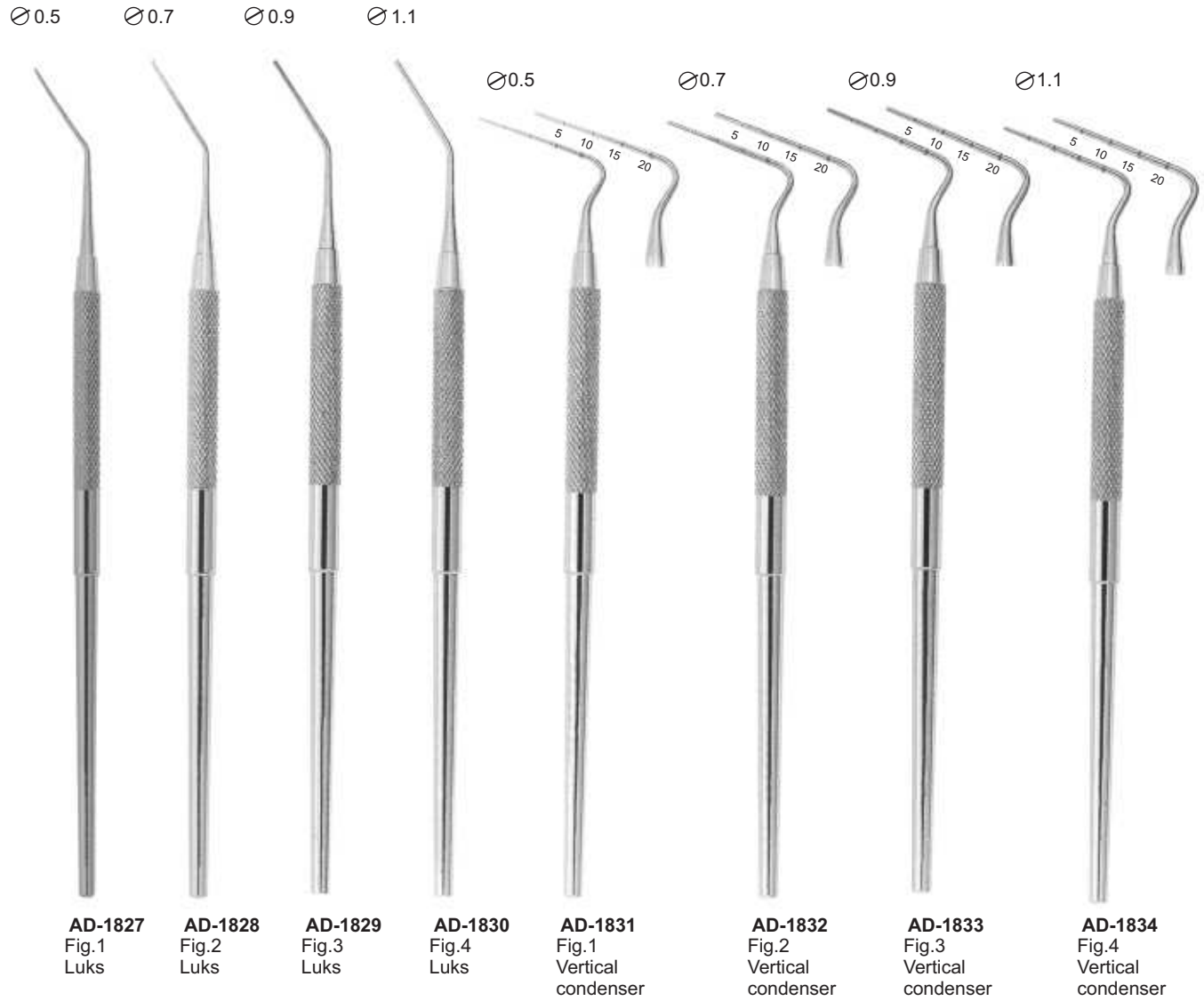

Endodontic set



AD-1835
Measuring Plate

Root-canal pluggers

Optimum Flexibility
Very Fine Points

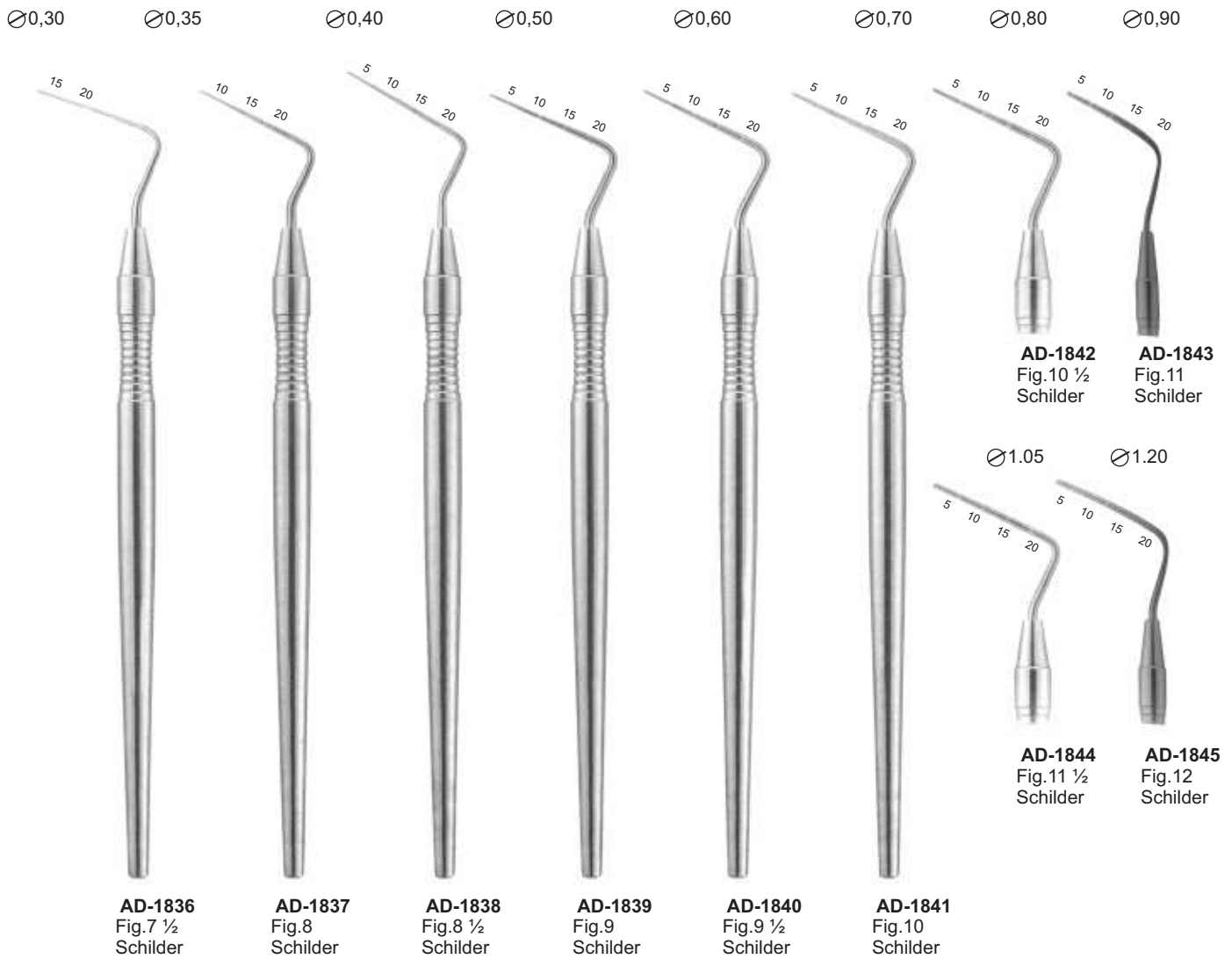

Root-canal explorers



AD-1846
Fig.6/1

AD-1847
Fig.6/17

AD-1848
Fig.6/23

Root-canal excavators

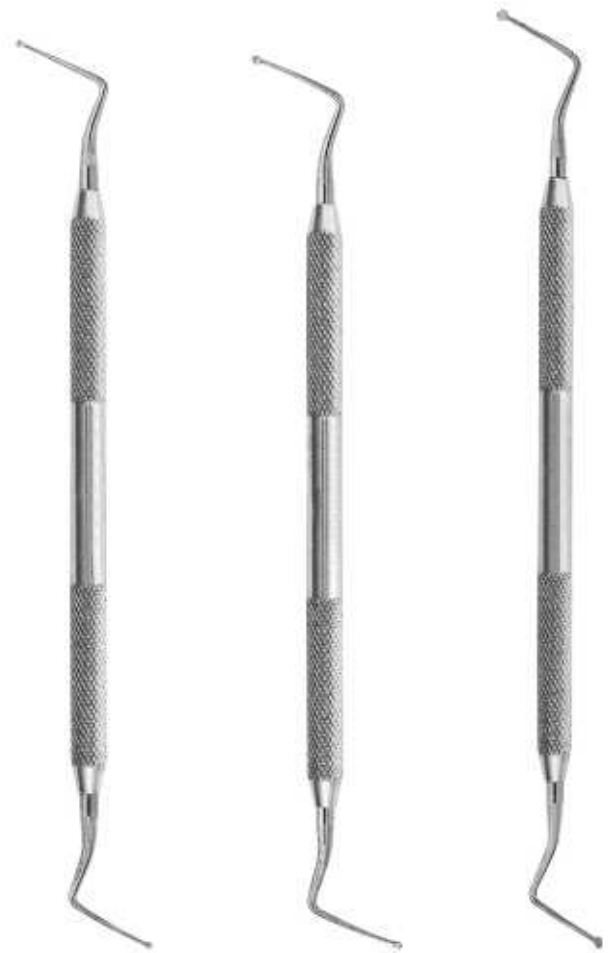

AD-1849
Fig.31L

AD-1850
Fig.32L

AD-1851
Fig.33L

1 mm



AD-1852
Fig 5

1.2 mm



AD-1853
Fig 14

1 mm



AD-1854
Fig 17

1.2 mm



AD-1855
Fig 18

1.6 mm



AD-1856
Fig 19

2 mm



AD-1857
Fig 20



1 mm



AD-1858
ASH
Fig.243

1,4 mm



AD-1859
ASH
Fig.G2

0,8 mm



AD-1860
Fig.1

0,8 mm



AD-1861
Fig.2

1 mm



AD-1862
Fig.11

1 mm



AD-1863
Fig.12

1,2 mm



AD-1864
Fig.21

1,2 mm



AD-1865
Fig.22

1,6 mm



AD-1866
Fig.31

1,6 mm



AD-1867
Fig.32

2 mm



AD-1868
Fig.41

2 mm



AD-1869
Fig.42

05 SECTION

HANDLES FOR MOUTH MIRRORS, SPATULAS,
NEEDLE HOLDERS, SYRINGES, DENTAL TWEEZERS,
RUBBER DAM & CLAMPS

Page 105-130



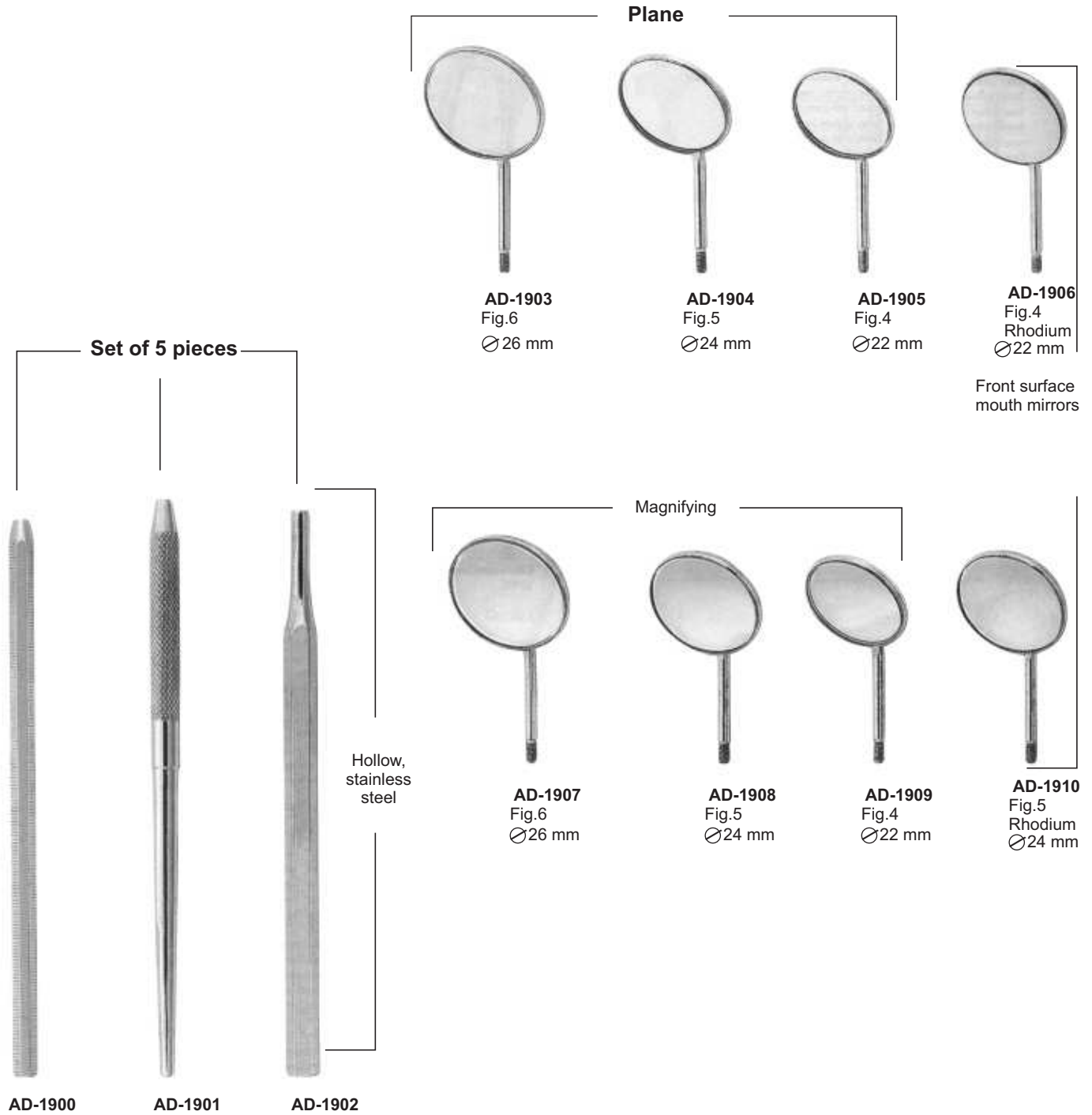



AD-1911



AD-1912



AD-1913



AD-1914



AD-1915



AD-1916
Parallelometer
mouth mirror

AD-1917
Parallelometer
mouth mirror
+ handle
code 2101

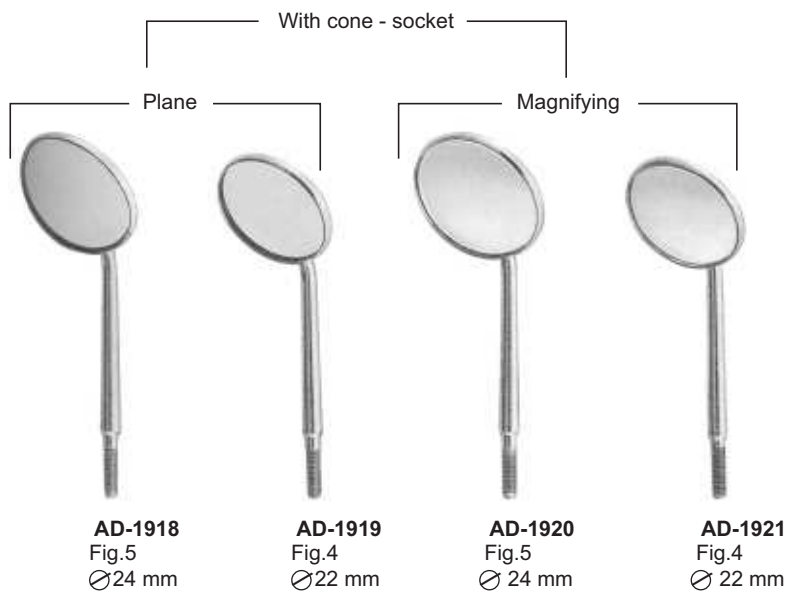

AD-1922
Cone - socket



AD-1923
Cone - socket



AD-1924
Cone - socket



AD-2000



AD-2001



AD-2002



AD-2003

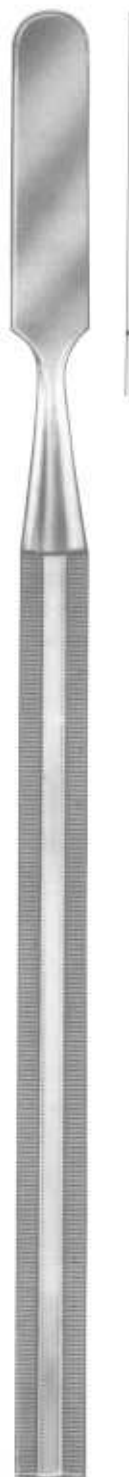

AD-2004



AD-2005



AD-2006



AD-2007

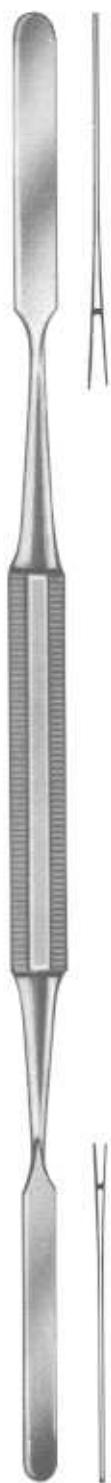

AD-2008



AD-2009



AD-2010



AD-2011



AD-2012



AD-2013



AD-2014









AD-2200
Mayo-Hegar
16 cm



AD-2201
Mayo-Hegar TC
16 cm



AD-2202
Mayo-Hegar
18 cm



AD-2203
Mayo-Hegar TC
18 cm



AD-2204
Mini-Ryder
18 cm



AD-2205
Mini-Ryder
15 cm



AD-2206
Derf
12 cm



AD-2207
Hegar-Baumgarther
14 cm



AD-2208
Crile-Wood
15 cm



AD-2209
Crile-Wood TC
15 cm



AD-2210
Adson
17.5 cm



AD-2211
Olsen-Hegar
14 cm



AD-2212
Baumgarther
14.5 cm



AD-2213
Gillies
16 cm



AD-2214
Gillies
16 cm



AD-2215
Hegar-Baumgarther
14 cm





AD-2216
Toennis
18 cm



AD-2217
Toennis
18 cm



AD-2218
Lichtenberg
17 cm



AD-2219
Lichtenberg
17 cm



AD-2220
Eiselberg-Mathieu
19.5 cm



AD-2221
Boynton
12 cm



AD-2222
Arruga
16 cm



AD-2223
Boynton
12 cm



AD-2224
Arruga
16 cm



AD-2225
Castroviejo
14 cm



AD-2226
Castroviejo
14 cm



AD-2227
Castroviejo
14/60 cm



AD-2228
Castroviejo
18 cm



AD-2229
Castroviejo
18 cm



AD-2230
Castroviejo
14 cm



AD-2231
Castroviejo
14 cm



AD-2232
Castroviejo
14/60 cm



AD-2233
Castroviejo
18 cm



AD-2234
Castroviejo
18 cm





AD-2235
Mathieu
14 cm



AD-2236
Mathieu
14 cm



AD-2237
Mathieu
14 cm



AD-2238
Mathieu
14 cm



AD-2239
Mathieu
17 cm



AD-2240
Mathieu
17 cm



AD-2241
Mathieu
14 cm



AD-2242
Micro-Barraquer
18 cm



The tips have tungsten carbide inserts for better handling.



AD-2243
Mathieu
17 cm



AD-2244
Mathieu
17 cm



AD-2245
Micro-Barraquer
14 cm



AD-2246
Castroviejo
13 cm



AD-2247
Castroviejo-Barraquer
13 cm



AD-2248
Castrpviejo
13 cm



AD-2249
Castrpviejo
13 cm



AD-2251
18.03mm,cm



AD-2252
18.04mm,cm



AD-2253
18.05mm,cm



AD-2254
Fig. 12FR
Fraizer
15.04mm,cm



AD-2255
Fig. 10FR
Fraizer
15.03,3mm,cm



AD-2256
Fig. 8FR
Fraizer
15.02,7mm,cm



AD-2250
Fig. 6FR
Fraizer
15.02mm,cm

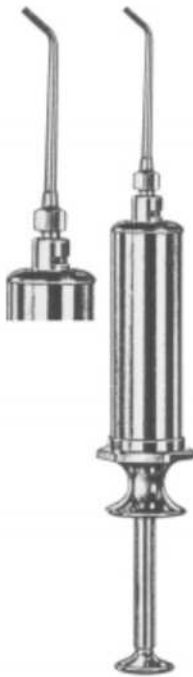

AD-2300
Water Syringe complete with
1 cannula (Lure-Lock)



AD-2301
Water Syringe complete with
1 cannula (Lure-Lock)



AD-2302
Metal water syringe, self-filling,
with 1 cannula (Lure-Lock)



AD-2303
Sparrel Barrel with
plunger suitable for
syringes



AD-2304
Cannula, only, with
Luer-Lock connector,
suitable for syringes



AD-2305
Aspirating Syringe

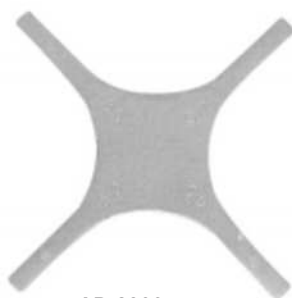

AD-2306
Position Gauge



AD-2307
Breech Loading Syringe



AD-2308
Aspirating & Breech Syringe



AD-2309
Band Adaptor



AD-2310
Endo Finger Ruler
With Adjustable Slide



AD-2311
Aspirating Syringe





AD-2312



AD-2314



AD-2313



AD-2317
Tip Only, short



AD-2319



AD-2318
Tip Only, long

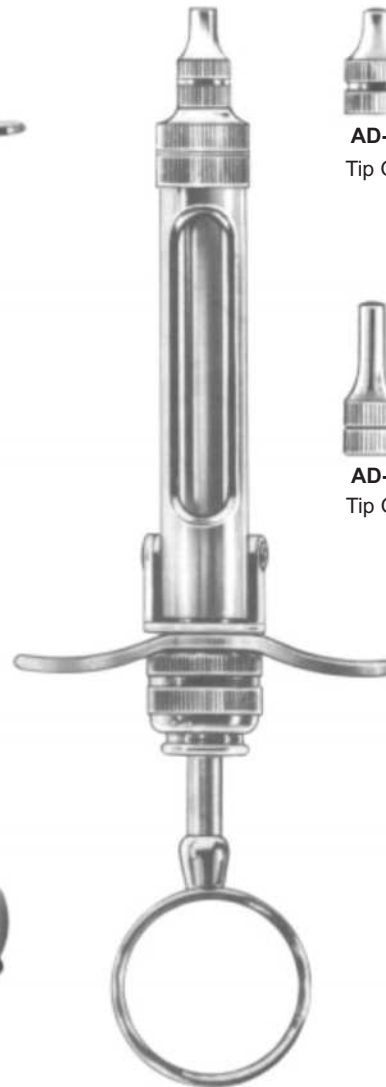

AD-2315 1,8 ml
AD-2316 2,2 ml

Cartridge Syringe complete
With 2 tips and without needles



AD-2320



AD-2321



AD-2322
Cork screw tip



AD-2323
Cork screw tip



AD-2324
Folding type, cork
screw tip



AD-2325
Folding type, cork
screw tip



AD-2326



AD-2327
Cork screw tip



AD-2328
Spare cap with
metric thread



AD-2329
With Whitworth
thread



AD-2330

Autoclavable Plastic Protection sleeve



AD-2331
Brass syringe with stainless steel moving parts



AD-2332
Brass syringe with stainless
steel moving parts

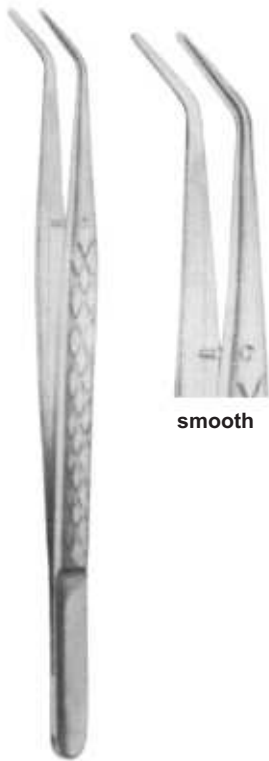

smooth

AD-2400
College
15 cm

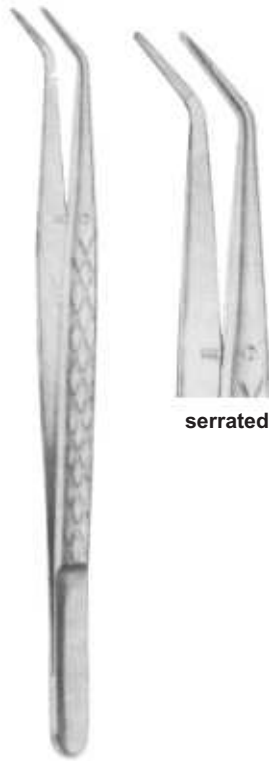

serrated

AD-2401
College
15 cm

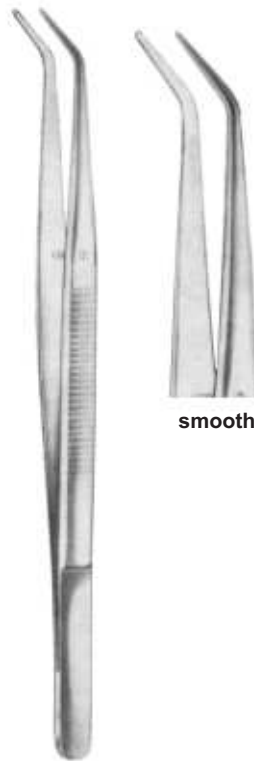

smooth

AD-2402
College
15 cm

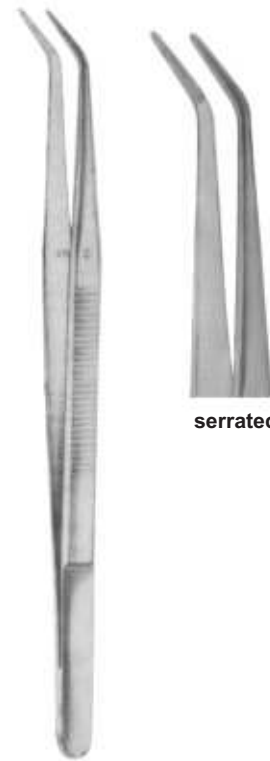

serrated

AD-2403
College
15 cm

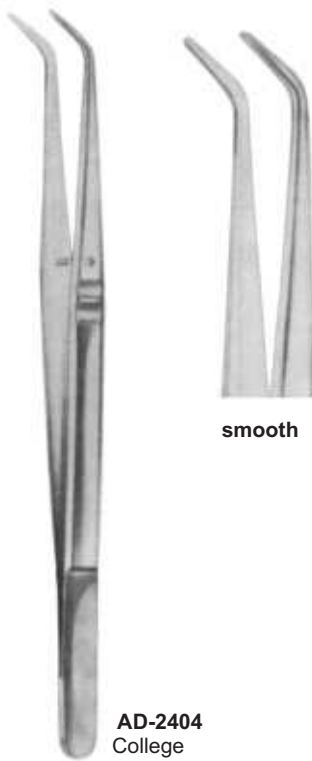

smooth

AD-2404
College
15 cm

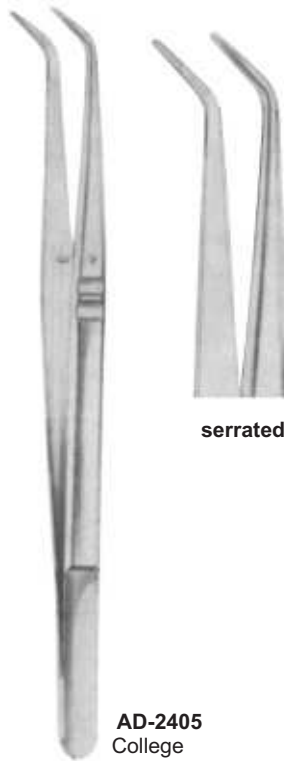

serrated

AD-2405
College
15 cm

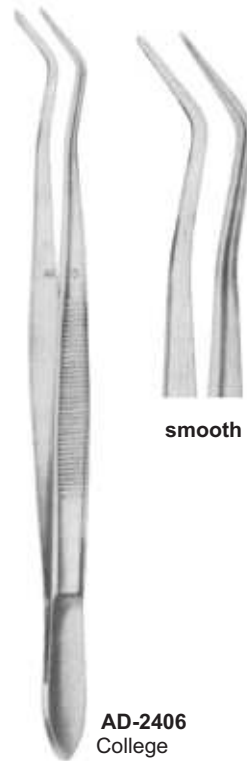

smooth

AD-2406
College
15 cm

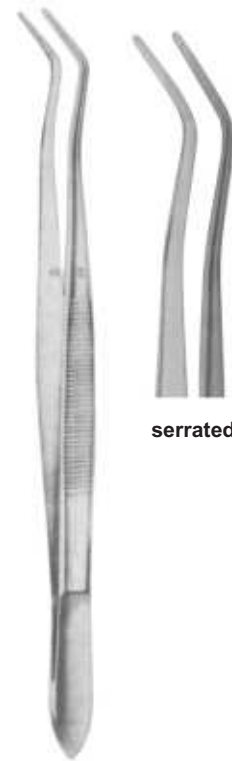

serrated

AD-2407
College
15 cm

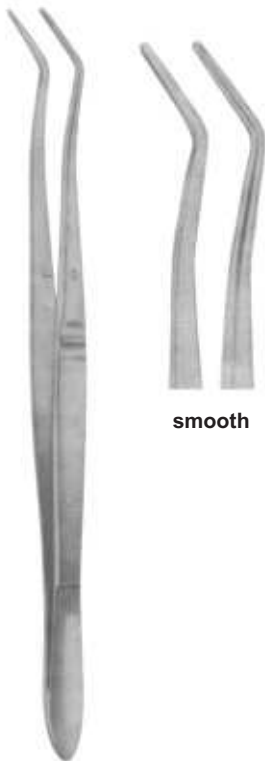

smooth

AD-2408
Meriam
16 cm

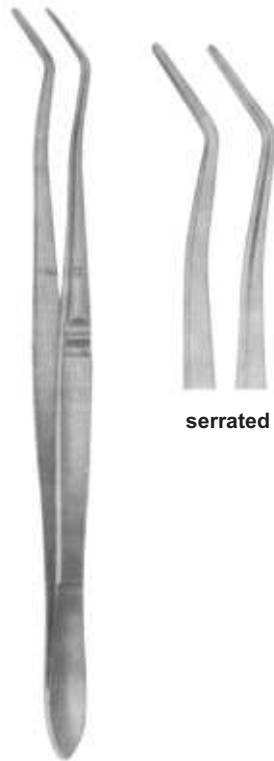

serrated

AD-2409
Meriam
16 cm

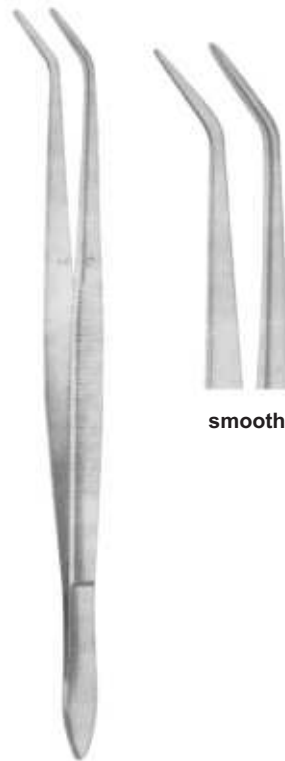

smooth

AD-2410
Meriam
16 cm

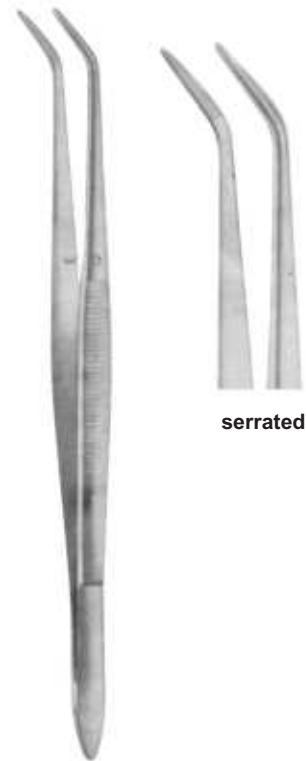

serrated

AD-2411
Meriam
16 cm

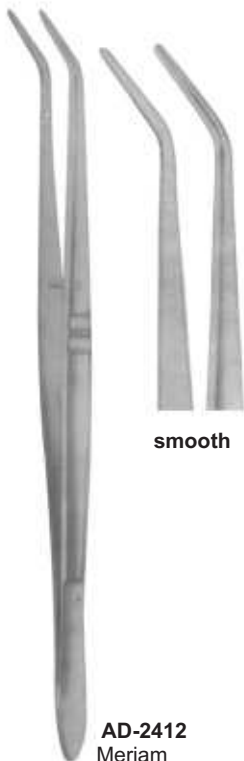

smooth

AD-2412
Meriam
16 cm

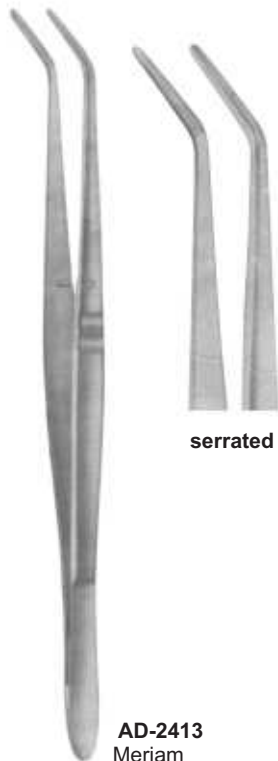

serrated

AD-2413
Meriam
16 cm

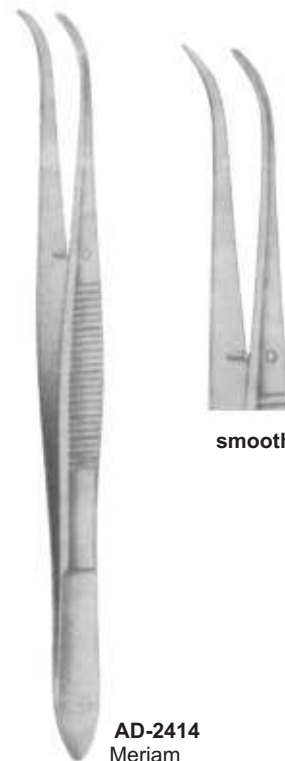

smooth

AD-2414
Meriam
16 cm

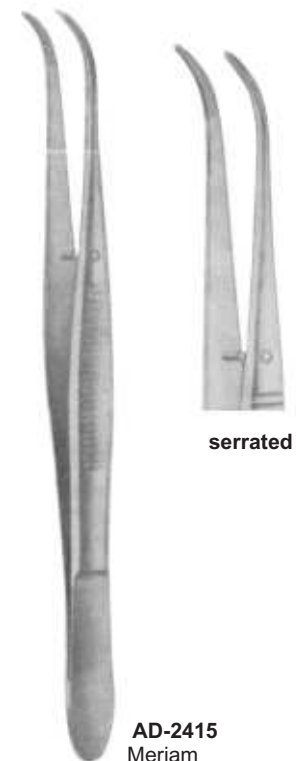

serrated

AD-2415
Meriam
16 cm



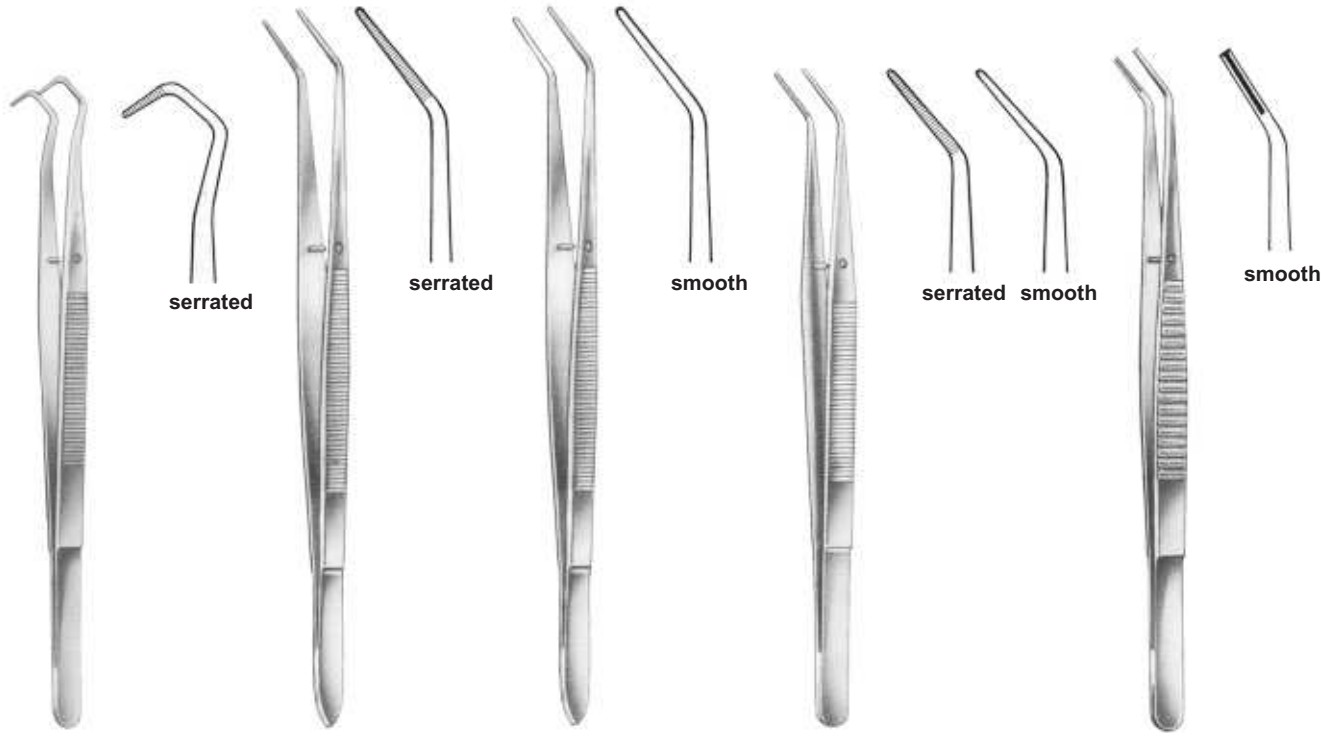

AD-2416
College
14.5 cm, 5³/₄"

AD-2417
Flagg
16 cm, 6¹/₄"

AD-2418
Flagg
16 cm, 6¹/₄"

AD-2419
Landgraf
15 cm, 6"

AD-2420
15.5 cm, 6¹/₈"

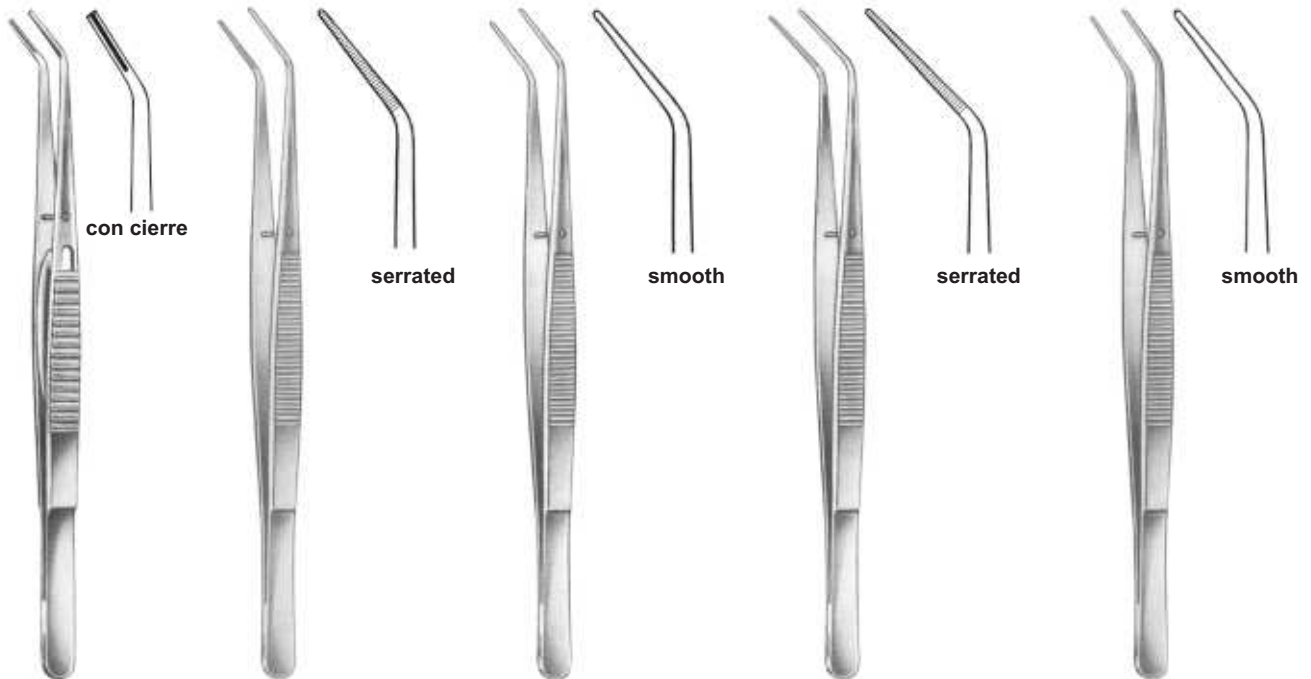

AD-2421
15.5 cm, 6¹/₈"

AD-2422
London-College
15 cm, 6"

AD-2423
London-College
15 cm, 6"

AD-2424
London-College
15 cm, 6"

AD-2425
London-College
15 cm, 6"



AD-2426
CK1
15 cm, 6"



AD-2427
CK2
15 cm, 6"



AD-2428
GF2
16 cm, 6 1/4"



AD-2429
Gf1
16 cm, 6 1/4"

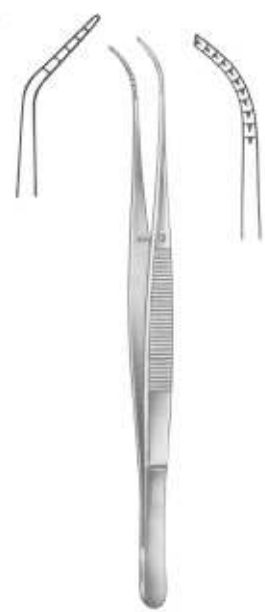

AD-2430
Kopp
15.5 cm, 6 1/8"



AD-2431
Kopp
15.5 cm, 6 1/8"



AD-2432
15 cm, 6"



AD-2433
16.5 cm, 6 1/2"



AD-2434
15.5 cm, 6 1/8"



AD-2435
15.5 cm, 6 1/8"



AD-2436
London-College
15 cm, 6"

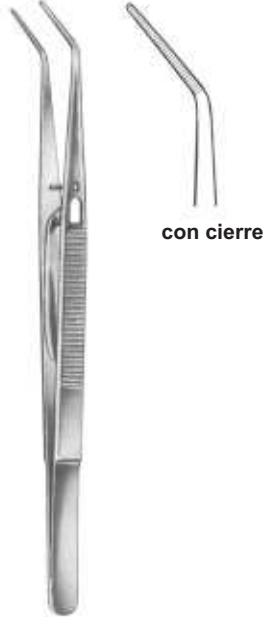

AD-2437
London-College
15 cm, 6"

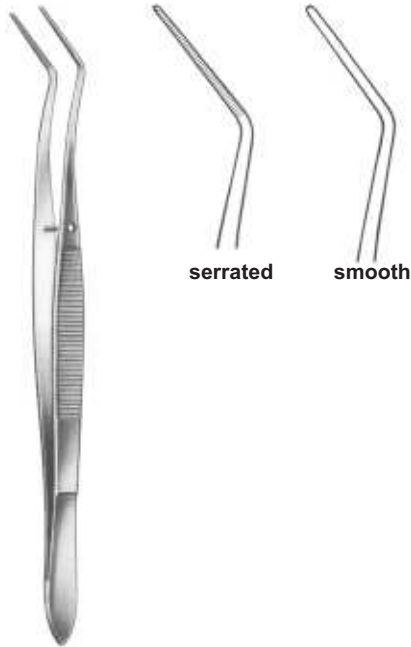

AD-2438
Meriam
16 cm, 6 1/4"



AD-2439
Allen
18 cm, 7 1/8"



AD-2440
Albrecht
16 cm, 6 1/4"

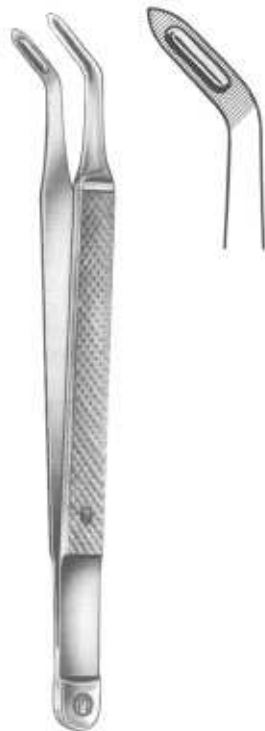

AD-2441
Albrecht
16 cm, 6 1/4"



AD-2442
16 cm, 6 1/4"



AD-2443
16 cm, 6 1/4"



AD-2444
16 cm, 6 1/4"

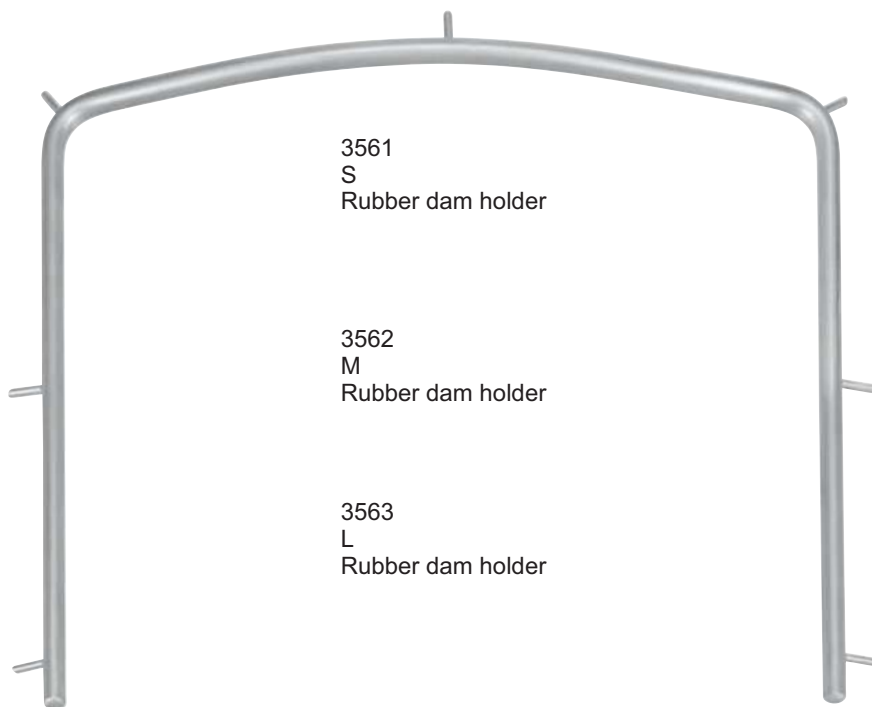

3561
S
Rubber dam holder

3562
M
Rubber dam holder

3563
L
Rubber dam holder



AD-3552
IVORY
16,0 cm
Punch forceps



AD-3550
AINSWORTH
17,0 cm
Punch forceps





AD-3555
STOKE
17,0 cm
Clamp forceps

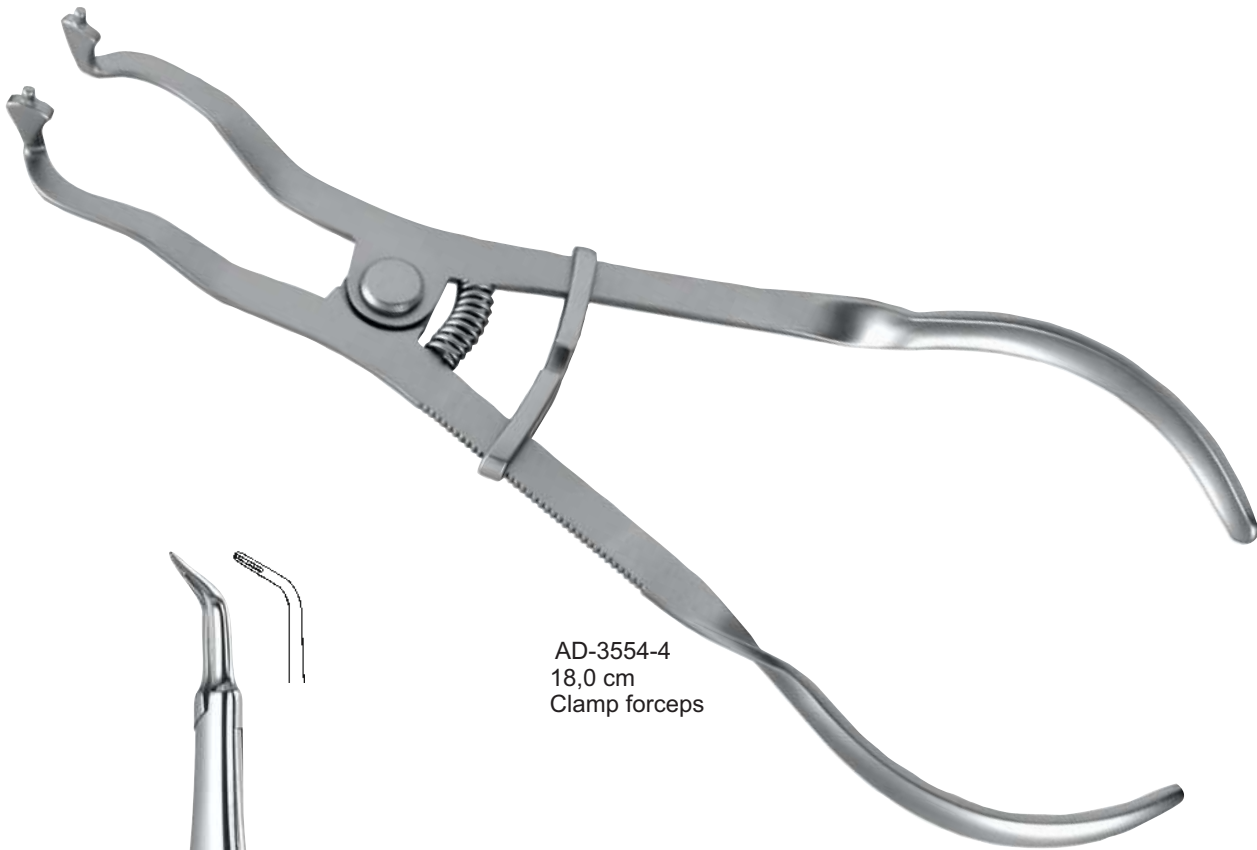

AD-3554-4
18,0 cm
Clamp forceps



AD-3661

Endoforceps





2510 - 9
Winged
Labial Clamp



2511 - 9T
Winged
Edged Labial Clamp



2512 - 212
Winged
Cervical Clamp



2513 - 210
Winged
Labial Clamp

Premolars



2514 - 00
Winged



2515 - 0
Winged



2516 - W0
Wingless

For Small Teeth, Elongated or With Narrow Collars



2517 - 1
Winged



2518 - 1T
Winged



2519 - W1
Wingless

**For General Use With Adjustable Jaws According
To Gingival Line Shapes**



2520 - 2A
Winged



2521 - 2AT
Edged, Winged



2522 - W2A
Wingless

For Premolars, With Elongated Collar



2523 - 2
Winged



2524 - 2T
Edged, Winged



2525 - W2
Wingless

For Premolars, With Elongated Collar



2526 - 29
Wingless



2527 - 60
Wingless



For Small Lower Molars

For Small Lower Molars With Round clamps



For Square Lower Molars

For Round Upper Molars



For Molar Roots

For Partially Broken Molars



For Round Molars, Partially Broken, Undersized or Inclined



**2545 - 26
Wingless**

**2246 - 51
Wingless**

**2547 - 202
Winged**

**2548 - 205
Winged**

Rubber Dam Clamp – Stabilizes and holds the dam secure.

Rubber Dam Clamp - Stabilizes and holds the dam secure.



<p>7245 12 DAM PLATE</p>	<p>7245 12 DAM PLATE</p>	<p>7246 12 DAM PLATE with DAMS (0, 1, 2, 2A, 4, 7, 8A, 9, 12A, 13A, 56, 212)</p>	<p>7246 12 DAM PLATE with DAMS (0, 1, 2, 2A, 4, 7, 8A, 9, 12A, 13A, 56, 212)</p>
-------------------------------------	-------------------------------------	---	---

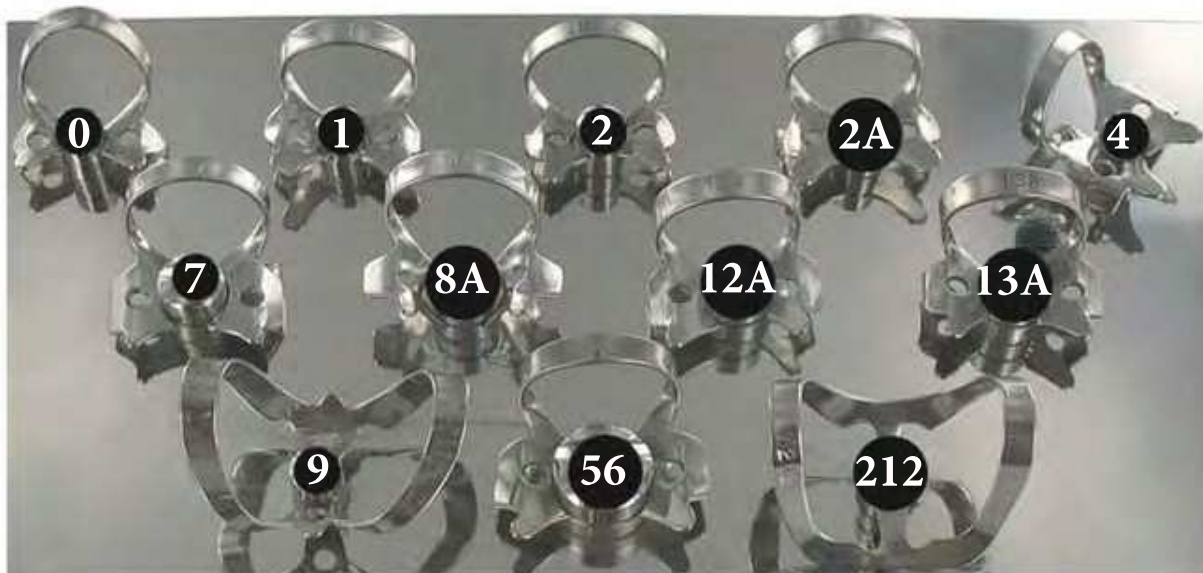

ANTERIOR : 212
PREMOLARS : 0, 1, 2, 2A, 9
UPPER MOLARS : 4, 56
LOWER MOLARS : 7, 12A, 13A
MOLARS-UNIVERSAL : 8A

ANTERIOR: 212
PREMOLARS: 0, 1, 2, 2A, 9
UPPER MOLARS: 4, 56
LOWER MOLARS: 7, 12A, 13A
MOLARS-UNIVERSAL: 8A

06 SECTION

MATRIX RETAINER, MATRIX BANDS, BONE RONGEURS
CROWN REMOVERS, SCISSORS, FORCEPS,
AMALGUM GUNS, CARRIES, COPPER RING REMOVING
PLIERS, PAPER ARTICULATOR FORCEPS

Page 131-144

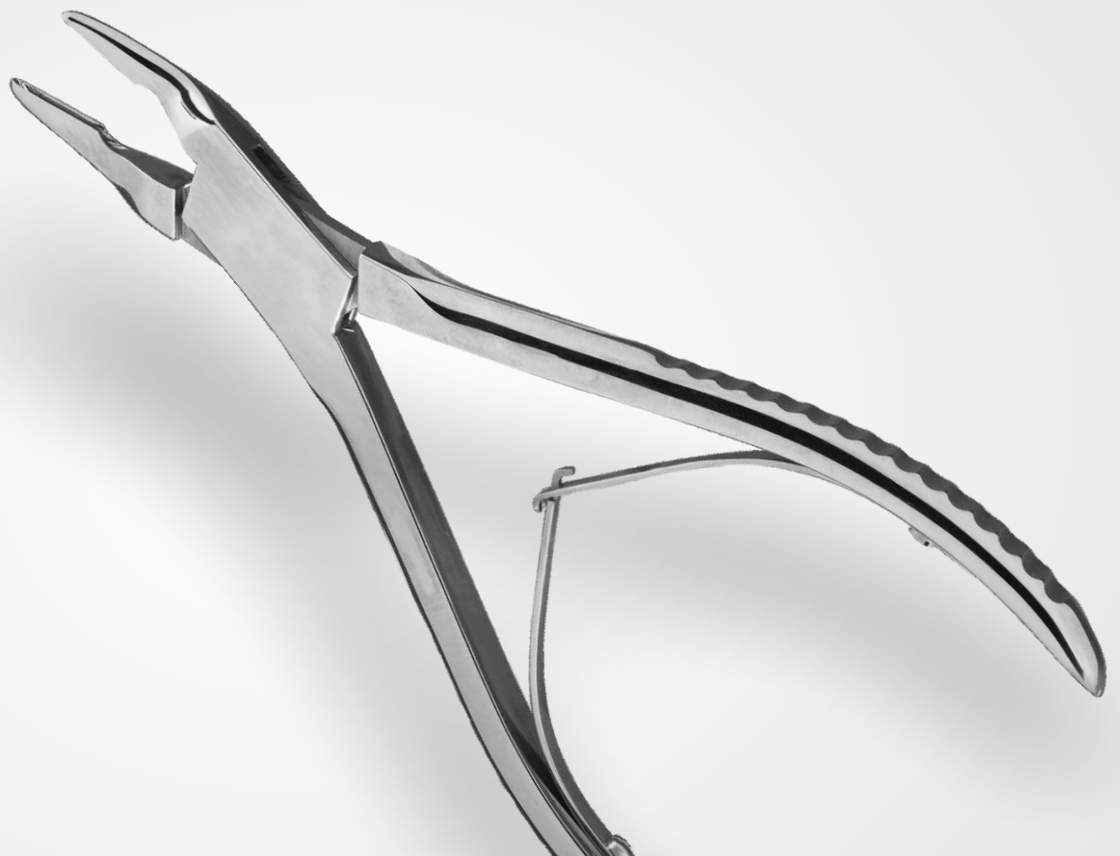



3585
FIG. 8
5,0 cm

3587
FIG. 8
7,0 cm



3590
TOFFLEMIRE
Universal



3590-1
TOFFLEMIRE
junior



3590-2
TOFFLEMIRE
Senior



3588-1
NYSTROM
L, 6,0 mm



3588-1
NYSTROM
R, 6,0 mm



3595
Matrix band on roll

1 m x 5.0 mm for 3585 / 3588-xx

3596
Matrix band on roll

1 m x 6.0 mm for 3587 / 3588-xx

3597
Matrix band on roll

1 m x 7.0 mm for 3587

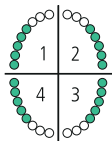

3593-1



3593-2



3593-3

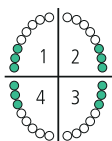

3594-11



3594-12



3594-13



3594-14



3592-1 TOFFLEMIRE



3592-2 TOFFLEMIRE



3592-3 TOFFLEMIRE



3591-0 IVORY



3591-1 IVORY



3591-2 IVORY





AD-4701
Crown Removers

AD-4702
Crown Removers

AD-4703
Crown Removers

AD-4704
Crown Removers



AD-4920
TREYMANN
16,0 cm

Shepherd's crook



AD-4924-10
MORELL

with tips AD-4924-1, AD-4924-2
and AD-4924-3

AD-4924
MORELL

with tips AD-4924-1 and AD-4924-2



AD-4925-10
MORELL

with tips AD-4924-1, AD-4924-2
and AD-4924-3

AD-4925
MORELL

with tips AD-4924-1 and AD-4924-2



AD-4924-1



AD-4924-2



AD-4924-3





Universal "HM"
12 cm, 4 3/4"



AD-2709



AD-2710



AD-2711
Beebee
10,5 cm, 4 1/8"



AD-2712
Mershon



AD-2713
Morell



AD-2714 AD-2715 AD-2716
Morell Morell Morell



AD-2717
Treyman



AD-2718
Automatic Crown Remover
With 2 Points



AD-2719



AD-2720



30°
With Metal Tip
AD-194

45°
With Metal Tip
AD-195

85°
With Metal Tip
AD-196





MINI
1.5mm
AD-198



LARGE
2.8mm
AD-199



REGULAR
2.0mm
AD-200



MINI
1.5mm
AD-210



REGULAR
2.0mm
AD-211

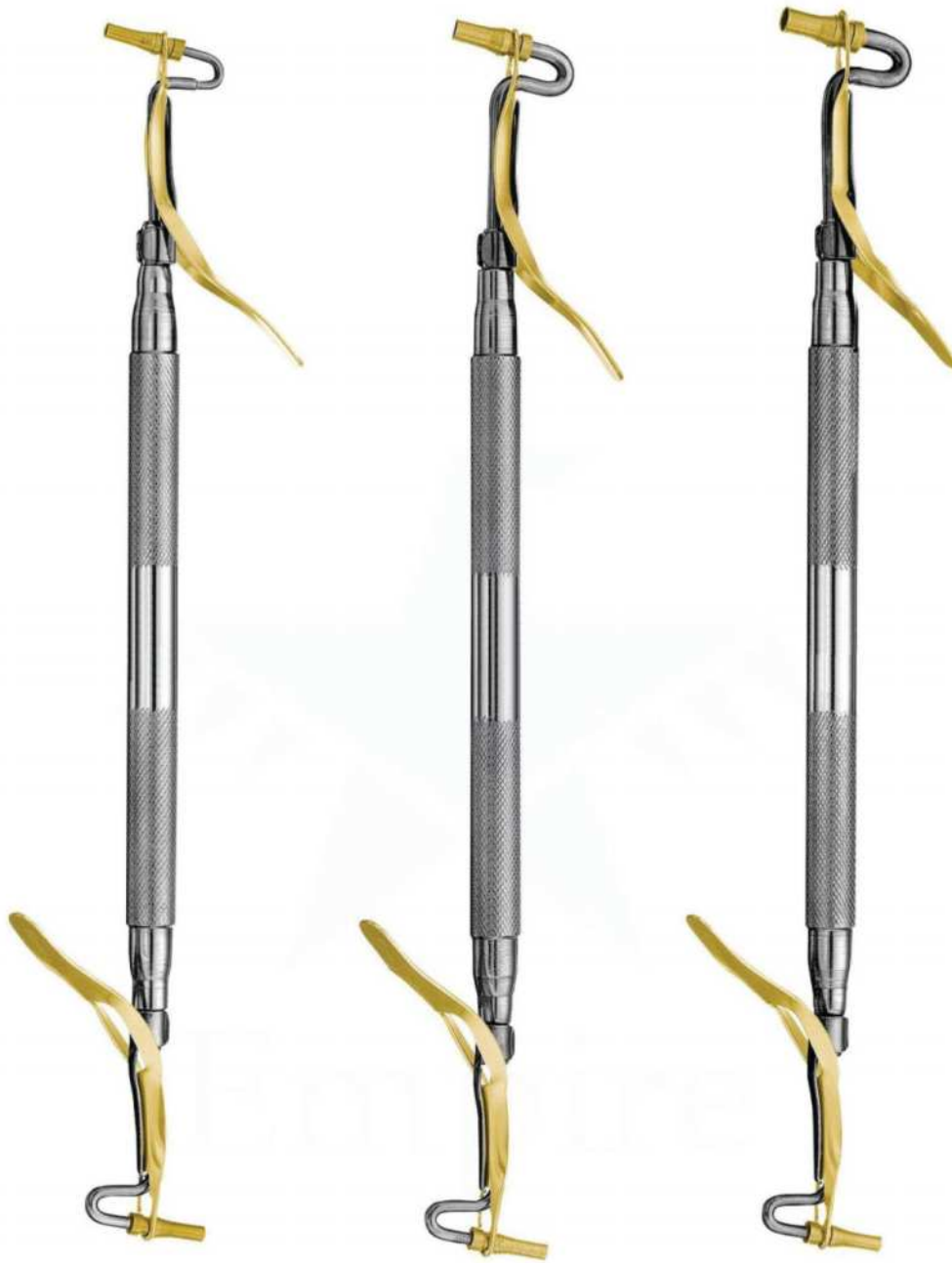

REGULAR MINI
1.5 x 2.0mm
AD-212

REGULAR LARGE
2.8 x 2.0mm
AD-213

REGULAR JUMBO
3.2 x 2.0mm
AD-214



Copper ring removing pliers



AD-2900
Bohm
11,5 cm



AD-2901
Bohm
14,5 cm



AD-2902
Furrer
16 cm



AD-2903
Furrer
16 cm



AD-2904
Miller
15 cm



AD-2905
Miller
15 cm



AD-2906
Kelly
14 cm



AD-2907
Halstead-Mosquito
12 cm



AD-2908
Micro-Mosquito
10 cm



AD-3000
Friedmann
14 cm, 5 1/2"



AD-3001
14 cm, 5 1/2"

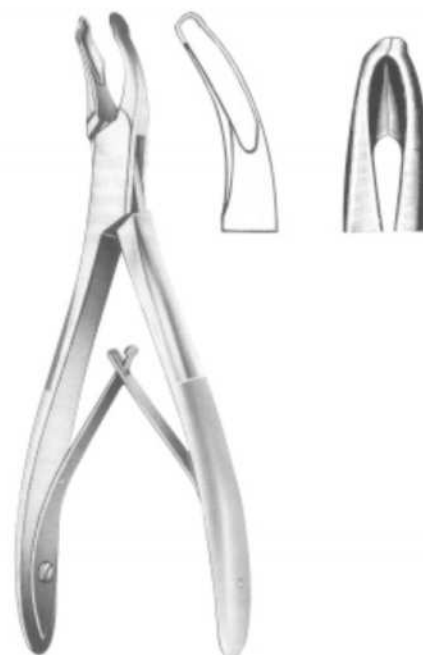

AD-3002
Mead
14 cm, 5 1/2"



AD-3003
Mead
14 cm, 5 1/2"



AD-3004
Mead
17 cm, 6 3/4"

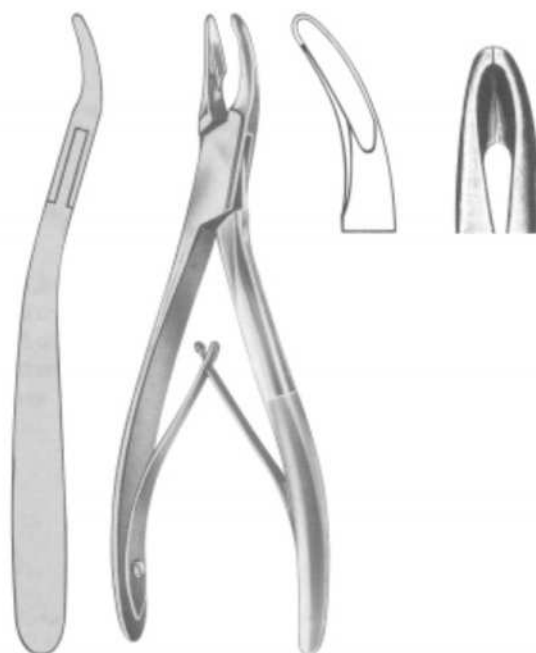

AD-3005
Schell
17 cm, 6 3/4"





AD-3006
Luer
15 cm



AD-3007
Friedman
14 cm



AD-3008
Mini Friedman
12 cm



AD-3009
Goldman-Fax
10 cm



AD-3010
Blumenthal
15 cm



AD-3011
Blumenthal 45
14,5 cm



AD-3012
Blumenthal 90
14 cm



AD-3013
Bohler
15 cm



AD-3014
Kerrison
15 cm



AD-3015
Blumenthal
16 cm, 6 1/4"



AD-3016
Blumenthal
16 cm, 6 1/4"



AD-3017
Blumenthal
16 cm, 6 1/4"



AD-3018
Kleinert-Kutz
14 cm, 5 1/2"



AD-3019
Ruskin-Mini
15 cm

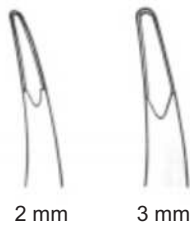

AD-3020
Beyer
18 cm, 7 1/8"



AD-3021
Zaufal-Jansen
18 cm, 7 1/8"





AD-3022
Niro
No. 5 S, 14 cm, 5 1/2"



AD-3023
Cleveland
No. 5 S, 17 cm, 6 3/4"



AD-3024
No. 18, 15 cm, 6"



AD-3025
Cleveland
16 cm, 6 1/4"



AD-3026
Gardner
16 cm, 6 1/4"



AD-3027
Liston-mini
15 cm, 6"

BONE ELEVATORS

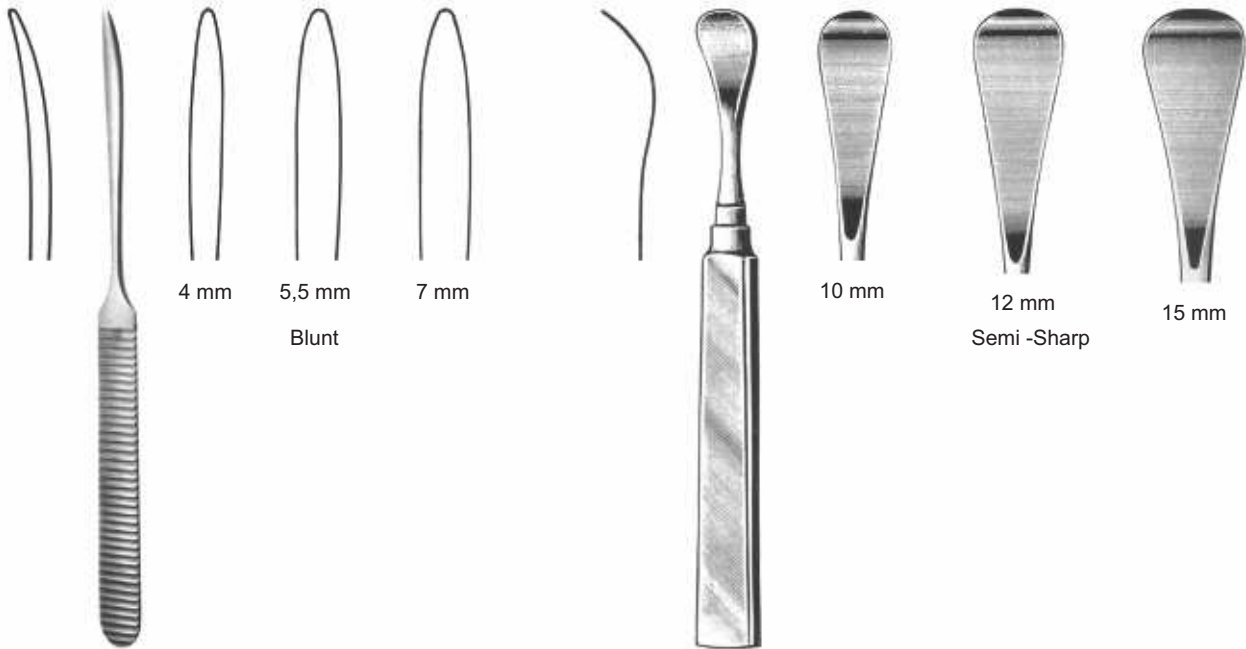

AD-3100
Williger
16 cm, 6 1/4"

AD-3101
Henahan
17 cm, 6 3/4"

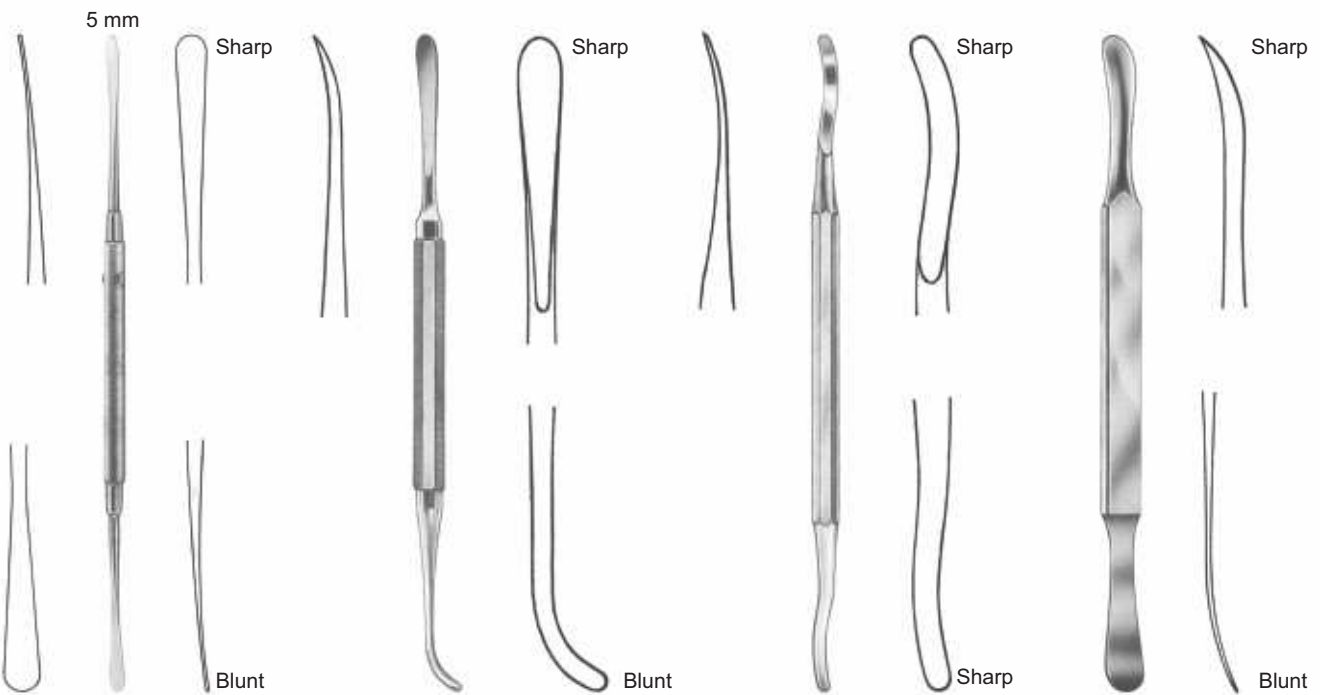

AD-3102
Freer
19 cm, 7 1/2"

AD-3103
Bennet
17 cm, 6 3/4"

AD-3104
Seldin
19 cm, 7 1/2"

AD-3105
Seldin
19,5 cm, 7 3/4"



Buckley
15 cm, 6"



AD-3106
No.1
3mm



AD-3107
No. 2
4mm



AD-3108
No. 3
5mm



AD-3109
No. 4
4mm



AD-3110
No. 5
4mm



AD-3111
Killian
16 cm, 6 1/4" 5 mm

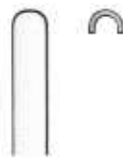

AD-3112
Killian-Claus
16 cm, 6 1/4" 5 mm

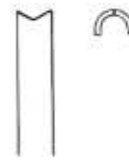

Obwegeser



AD-3113
2,5 mm



AD-3114
4 mm



AD-3115
Miller
No.10C



AD-3116
Miller
No.11C



AD-3117
Miller
No.12C



AD-3118
Miller
No.13C



07 SECTION

PLIERS FOR ORTHODONTICS
& IMPRESSION TRAYS

Page 145-157

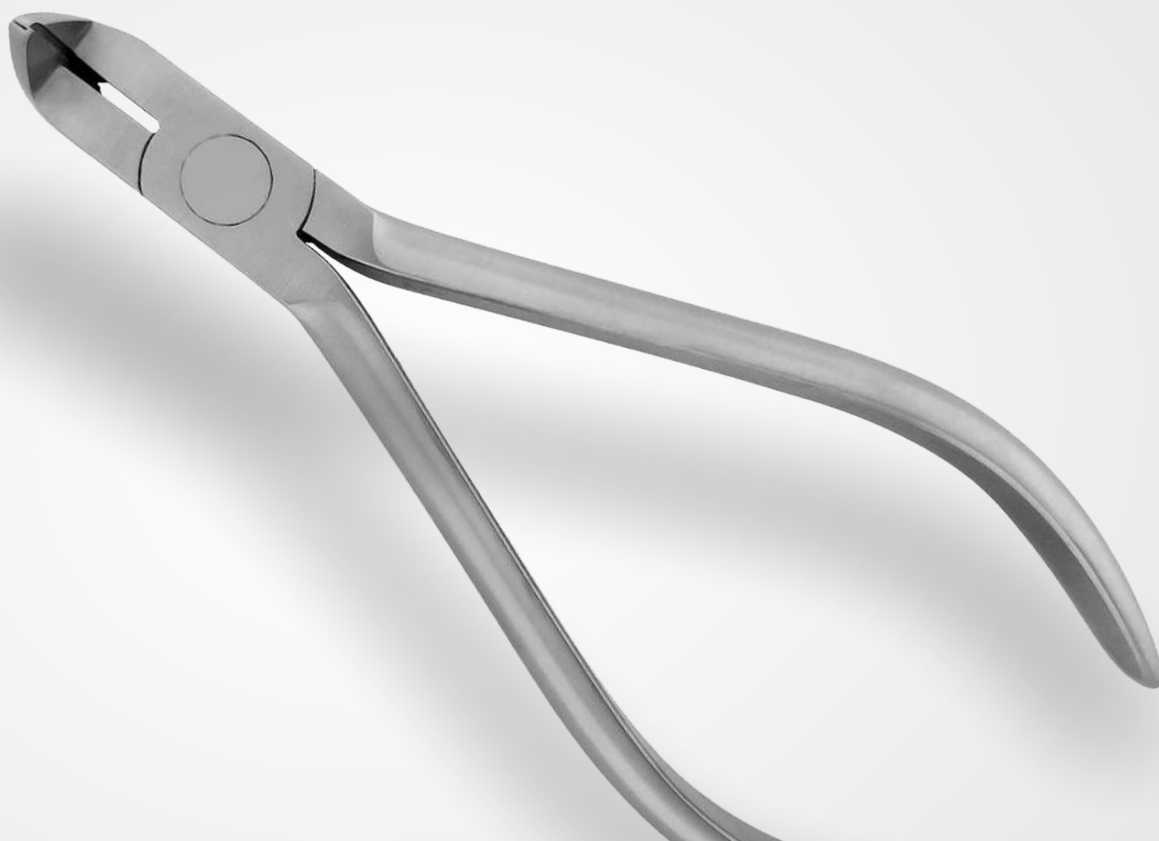

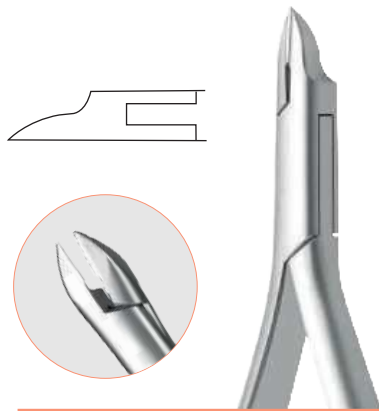

ODP-300
Micro Ligature Cutter
0,4 mm soft wire cutter

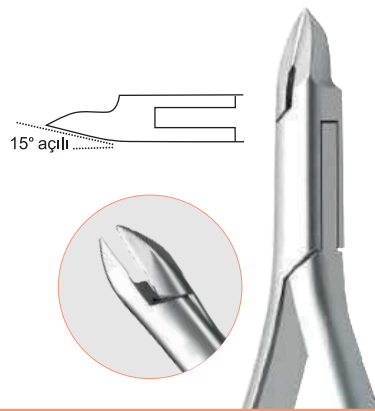

ODP-301
Micro Ligature Cutter
15 degree
0,4 mm soft wire cutter



ODP-302
Ligature Cutter
0,4 mm soft wire cutter

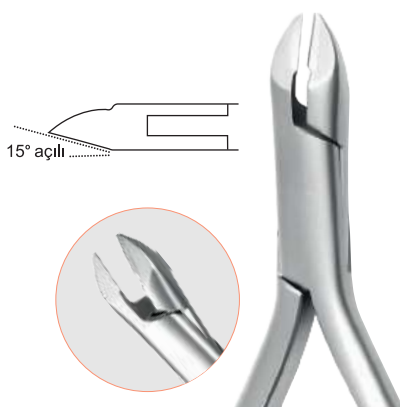

ODP-304
Ligature Cutter
15 degree
0,4 mm soft wire cutter



ODP-305
Ligature Cutter
Long handle
0,4 mm soft wire cutter

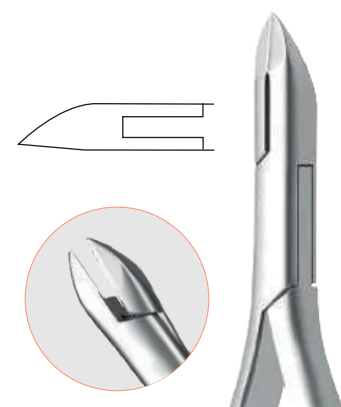

ODP-306
Ligature Cutter
Long head
0,4 mm soft wire cutter

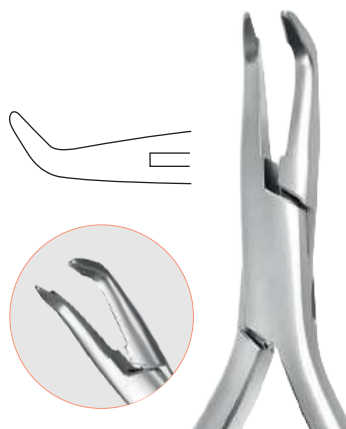

ODP-307
Reverse Ligature Cutter
40 Degree
0,4 mm soft wire cutter

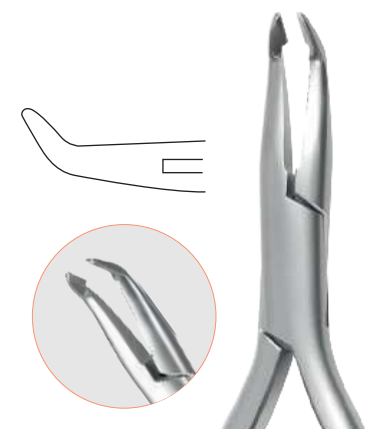

ODP-308
Ligature Cutter
40 Degree
0,4 mm soft wire cutter



ODP-309
Hard wire cutter
0,6 - 0,7 mm
can cut between.

ODP-310
Hard wire cutter
15 Degree
0,6 - 0,7 mm
can cut between.

ODP-311
Mini Distal Cutter
0,6 - 0,7 mm
can cut between.



ODP-312
Distal Cutter Long Handle
0,6 - 0,7 mm can cut between.

ODP-313
Flush Distal Cutter
0,5 mm suitable for wire.

ODP-314
Flush Distal Cutter
Long Handle
0,5 mm suitable for wire.



ODP-315
Laboratory hard
wire cutter
0,7 - 0,9 mm is suitable.



ODP-316
Laboratory hard wire
Cutter Plastic Handle
1,0 - 1,5 mm is suitable.

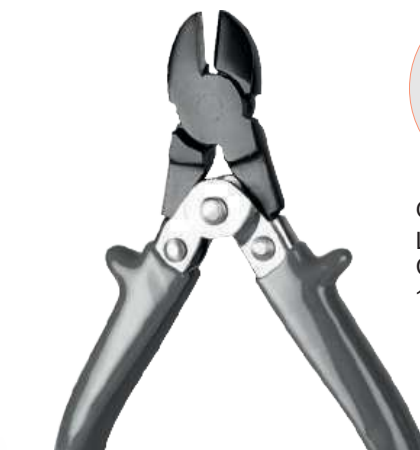



ODP-317
Weingart utility plier
0,5 mm'e is suitable

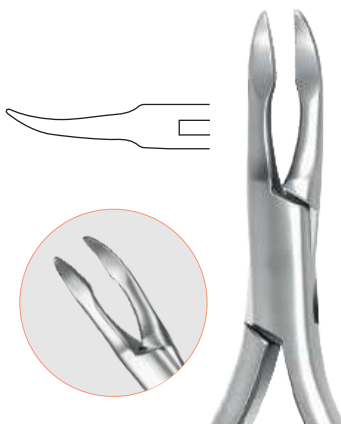

ODP-318
Weingart plier
0,5 mm is suitable

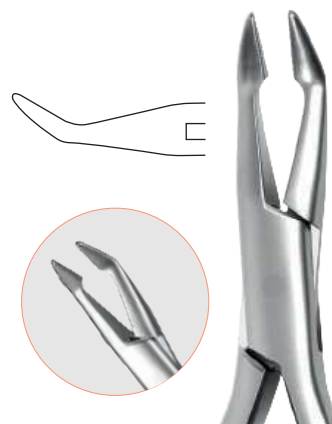

ODP-319
Weingart plier
Long head
0,5 mm is suitable



ODP-320
Weingart plier
Long head
0,5 mm'e is suitable

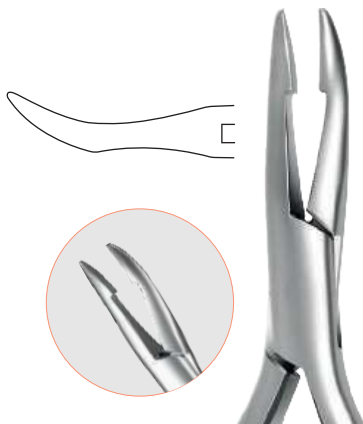

ODP-321
Weingart plier
Big
0,5 mm'e is suitable

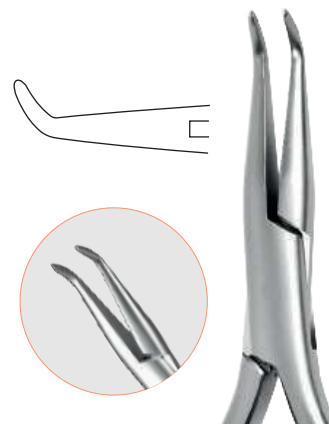

ODP-322
Weingart plier
0,5 mm'e is suitable

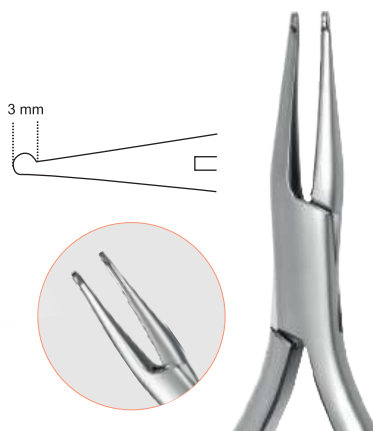

ODP-323
How Plier Straight

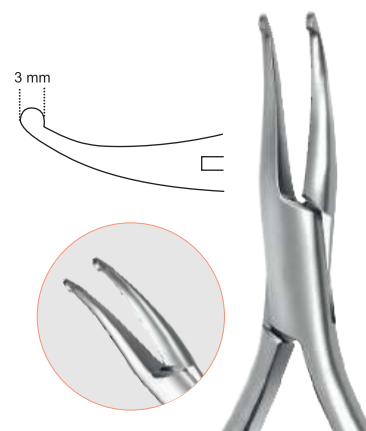

ODP-324
How Plier Curved

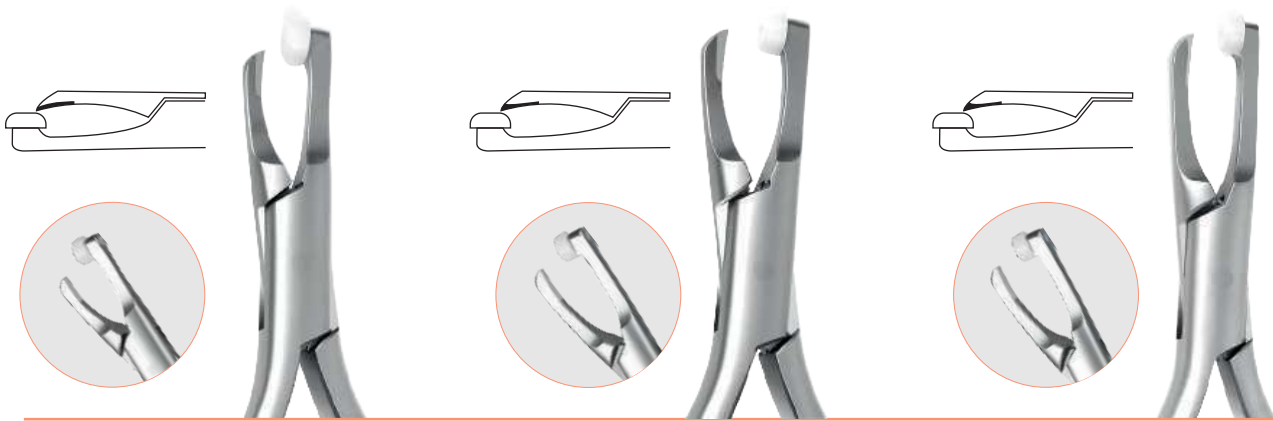

ODP-325
Posterior Band Removing
Plier Short

ODP-326
Posterior Band Removing
Plier Middle

ODP-327
Posterior Band Removing
Plier Long

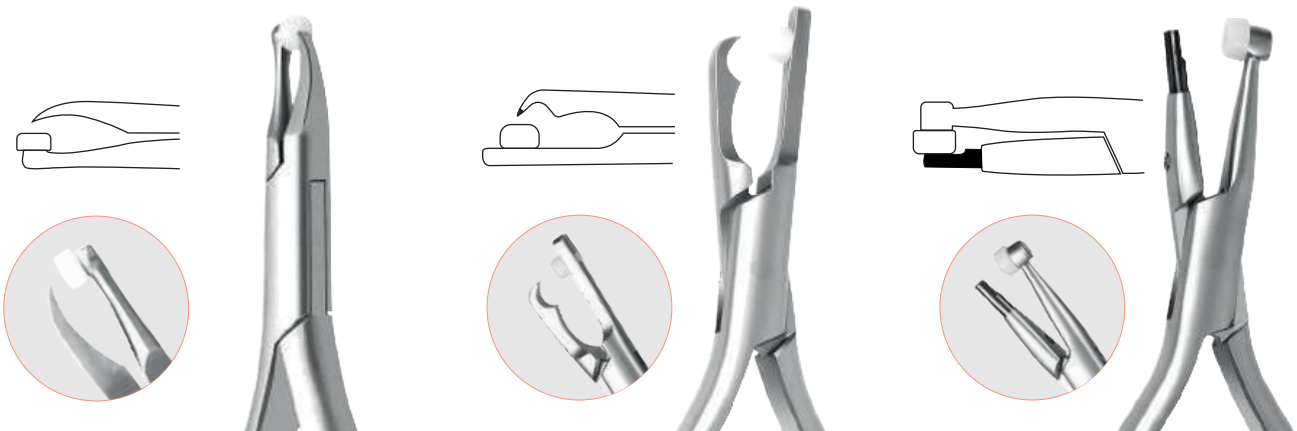

ODP-328
Micro Posterior Band
introducer Plier Sharp

ODP-329
Bracket And Adhesive
introducer Plier

ODP-330
Adhesive introducer Plier

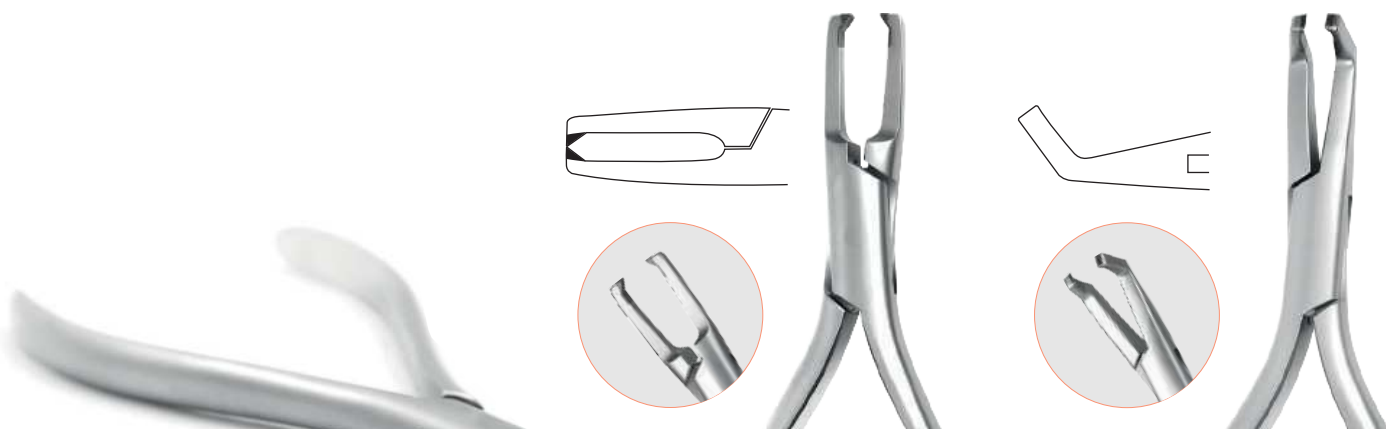

ODP-331
Bracket Debonding
Straight Plier

ODP-332
Bracket Debonding
Angled Plier

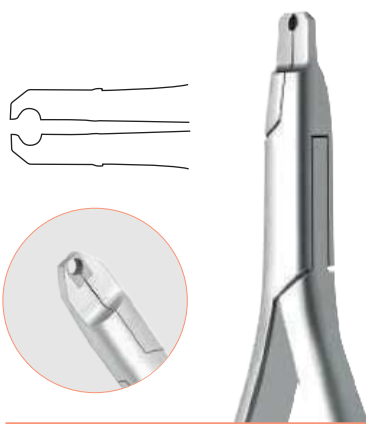

ODP-333
Debonding plier
straight

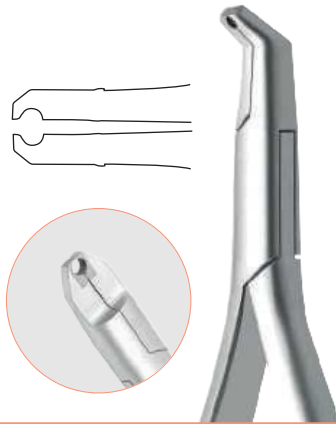

ODP-334
Angulated Debonding
Plier

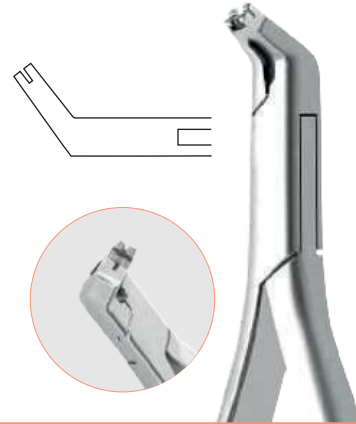

ODP-335
Angulated Debonding
Channel Plier

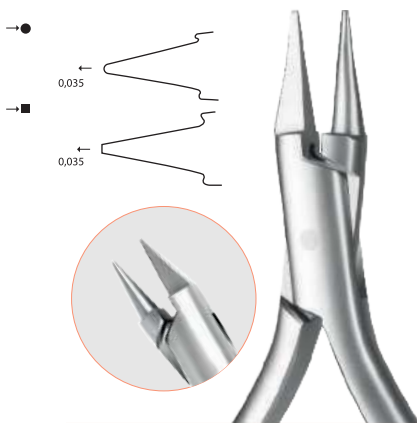

ODP-336
Lightwire Bird
Beak Plier
0,7 mm is suitable

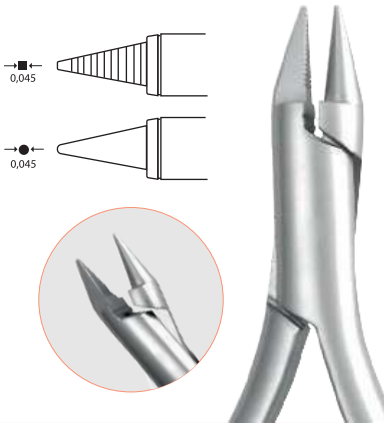

ODP-337
Lightwire Bird
Beak Plier Serrated
0,7 mm'e is suitable

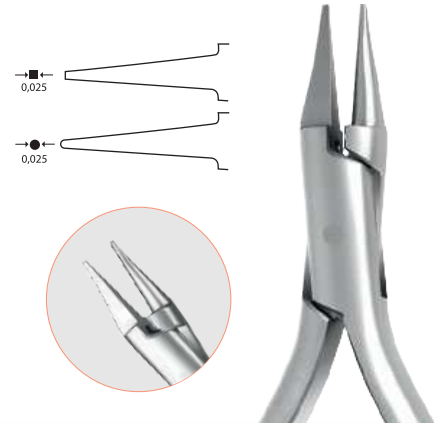

ODP-338
Bird Beak Plier
Long Handle
0,7 mm'e is suitable

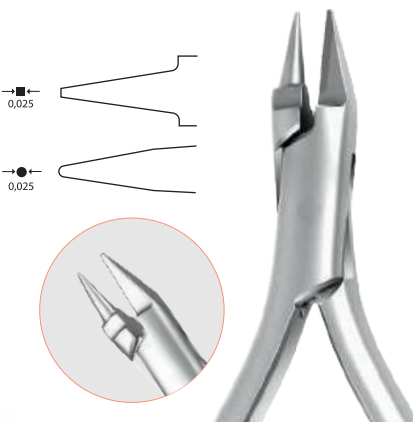

ODP-339
Micro Bird Beak
Plier
0,7 mm'e is suitable

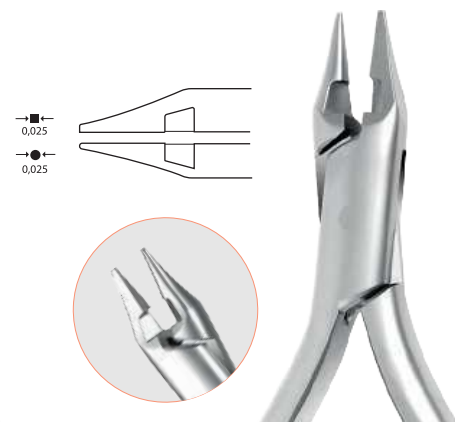

ODP-340
Micro Bird Beak
Plier with Cutter
0,7 mm'e is suitable

ORTHODONTICS PLIERS

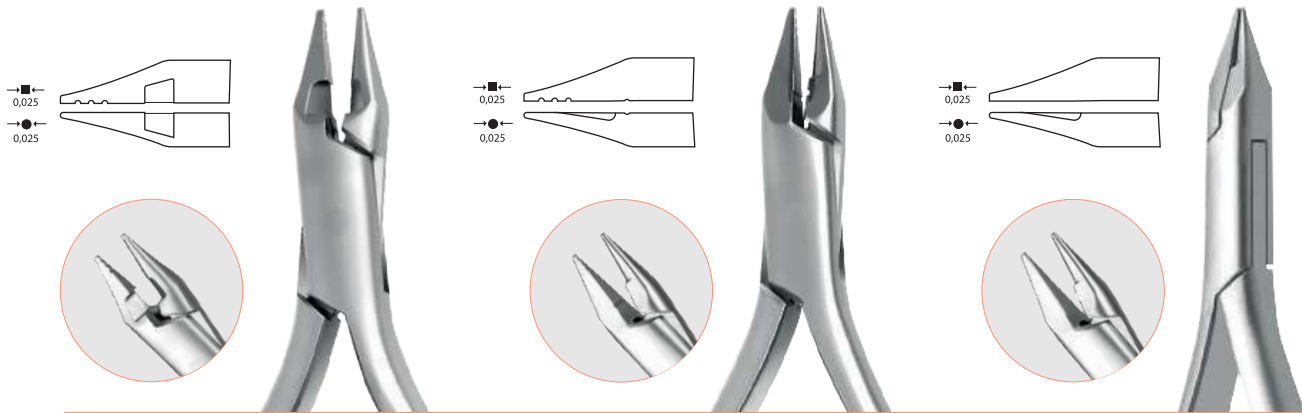

ODP-341
Bird Beak Plier
with Cutter and Grooves
0,7 mm'e is suitable

ODP-342
Bird Beak Plier
with 3 Grooves
0,7 mm'e is suitable

ODP-343
Light Bird Beak
Plier
0,7 mm'e is suitable.

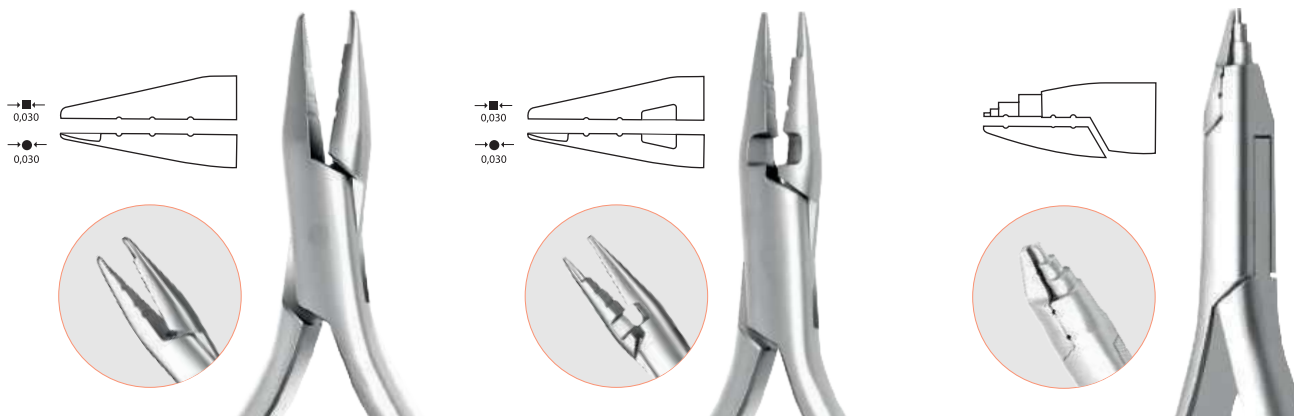

ODP-344
JaraBack Plier
0,5 mm'e is suitable

ODP-345
JaraBack Plier
with Cutter
0,5 mm'e is suitable

ODP-346
Young Plier
0,7 mm'e is suitable



ODP-347
Adam Plier
0,8 mm'e is suitable

ODP-348
Lingual Arch Forming
Plier
0,9 mm'e is suitable

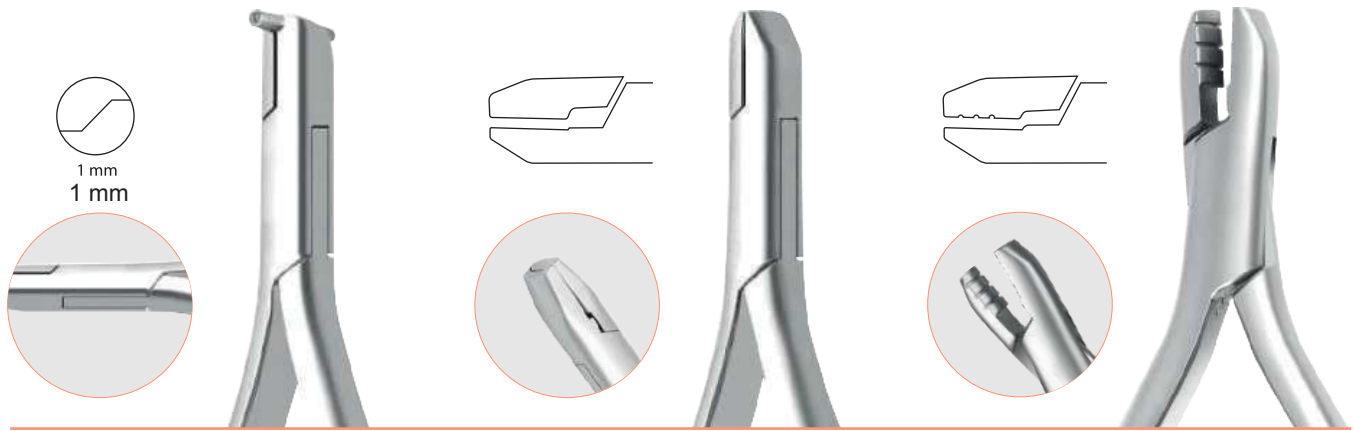

ODP-349
Step Plier
1,0 mm'e is suitable

ODP-350
De La Rosa
Plier
1,0 mm'e is suitable

ODP-351
De La Rosa
Plier with Grooves

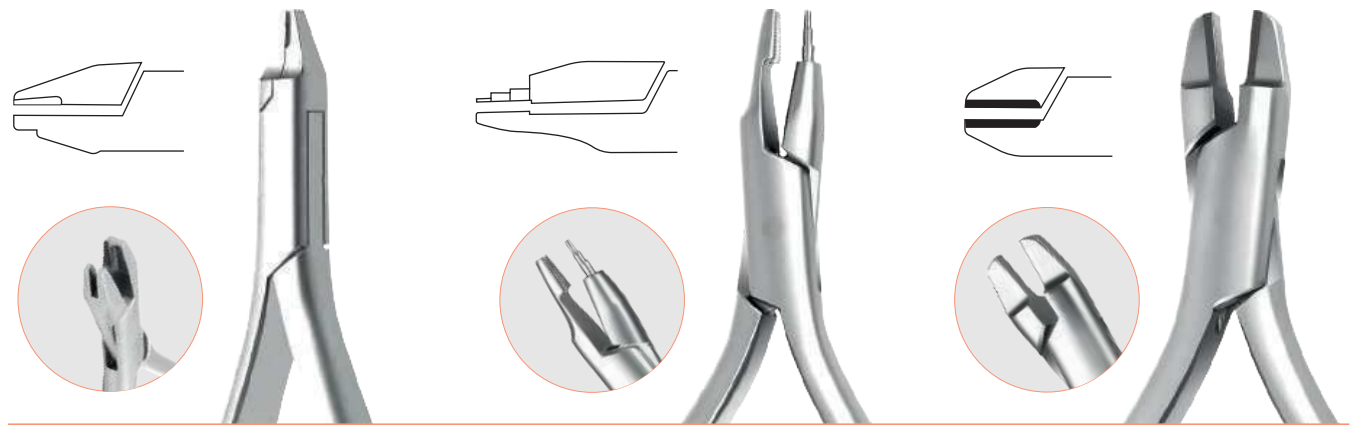

ODP-352
Hook Crimping
Plier

ODP-353
Tweed Loop Forming
Plier
0,5 mm'e is suitable

ODP-354
Torque Plier
Male

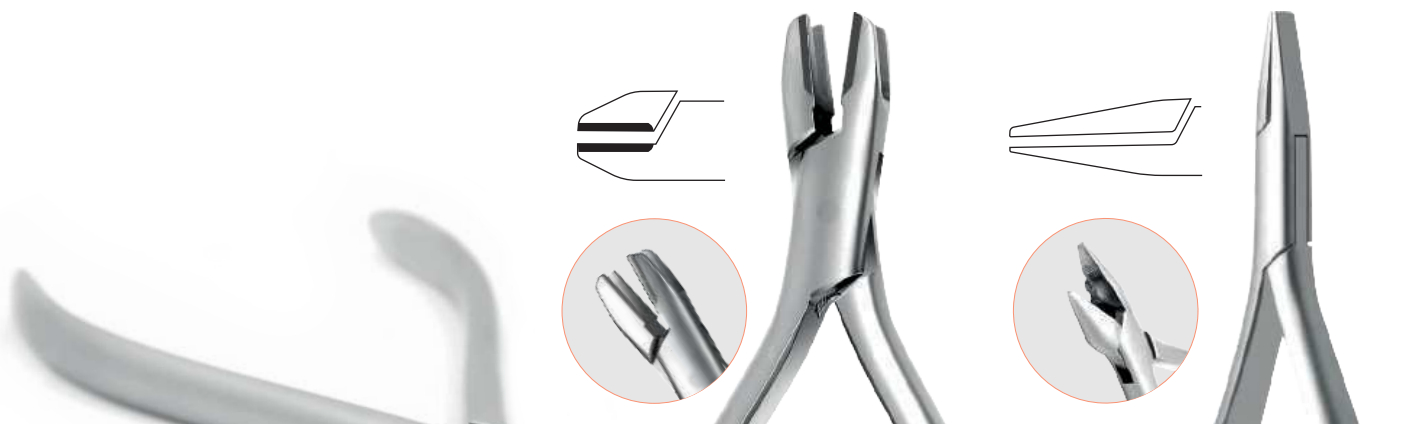

ODP-355
Torque Plier
Female

ODP-356
Hollow Plier

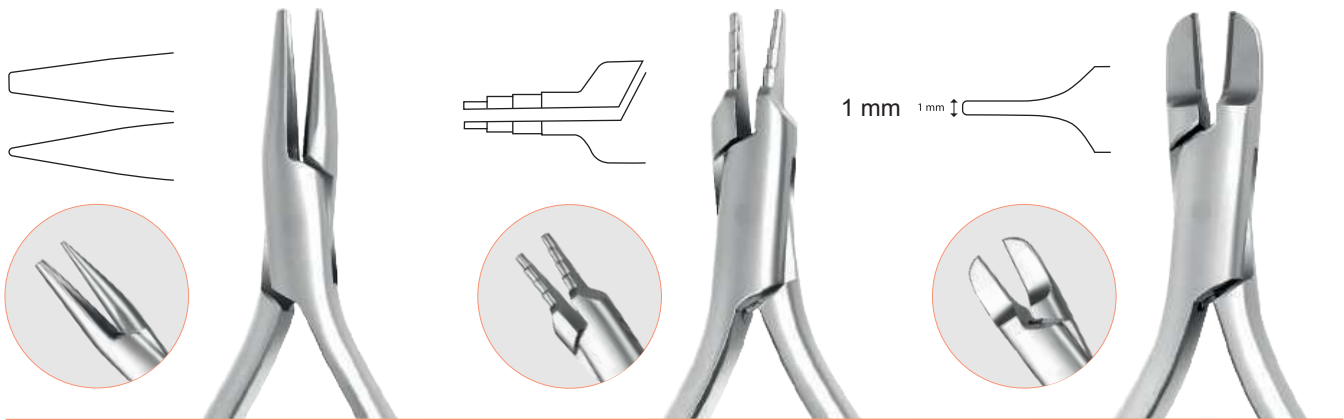

ODP-357
Optical Plier
0,5 mm'e is suitable

ODP-358
Nance Loop
Forming Plier
0,7 mm'e is suitable

ODP-359
Tweed Plier
1,0 mm'e is suitable

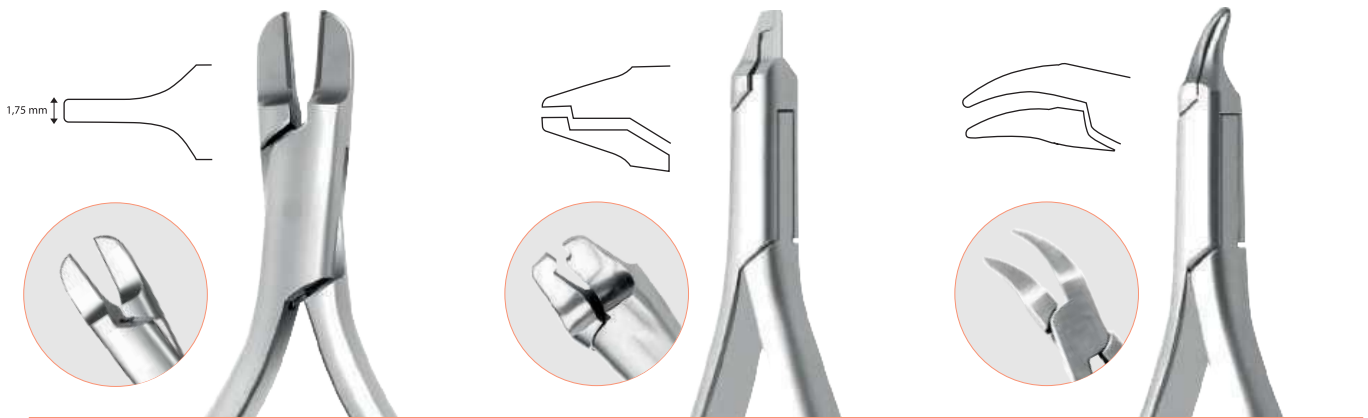

ODP-360
Tweed Plier
2,0 mm'e is suitable

ODP-361
Crown And Band Crimping Plier
For Round Wire

ODP-362
Reynolds Contouring
Pliers

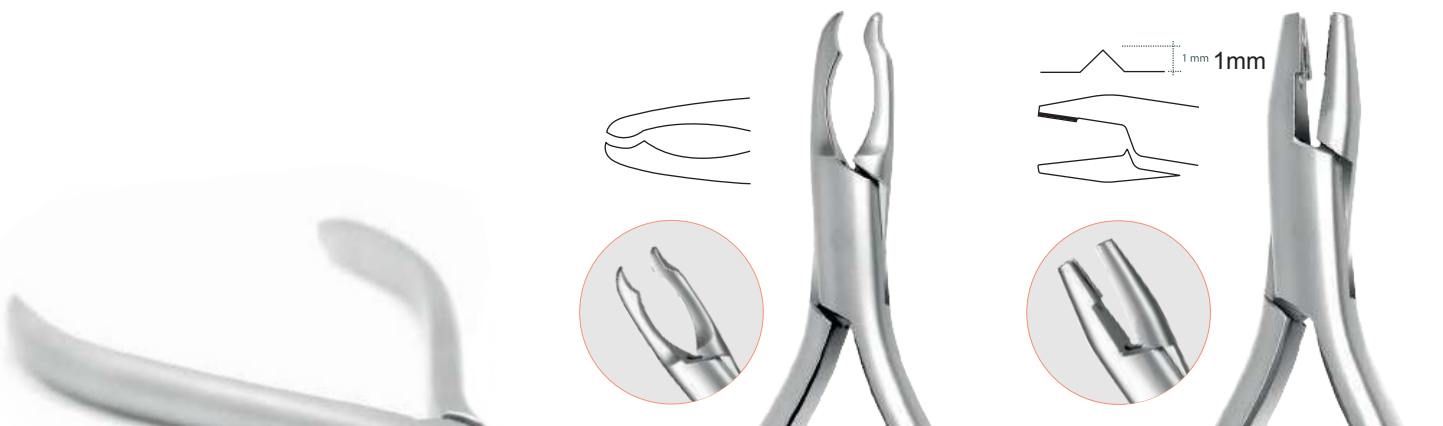

ODP-363
Crown Band Contouring
Plier

ODP-364
V-Bending plier
1,0 mm'e is suitable





ODP-365
Mini Three Jaw
Plier
0,5 mm'e is suitable

ODP-366
Three Jaw Plier
0,5 mm'e is suitable

ODP-367
Hammerhead Niti Distal
Cinch Back Plier Long Handle
0,4 mm'e is suitable



ODP-368
Hammerhead Niti Distal
Cinch Back Plier
0,4 mm'e is suitable

THODONTICS

All Impression Trays Upper & Lower Type
are available in S, M, L & XL Sizes



AD-3300
"HYDRO-LOCK"
stainless steel
water-cooled
impression trays
with retention rim.

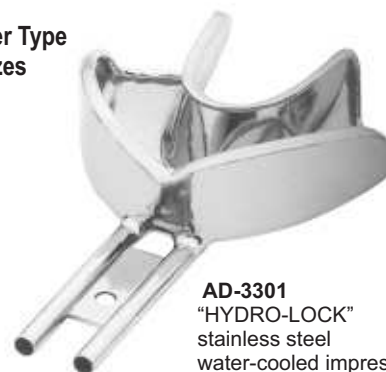

AD-3301
"HYDRO-LOCK"
stainless steel
water-cooled impression
trays with retention rim.



AD-3302
"NEW SUPER"
stainless steel
impression trays
with retention rim.



AD-3303
"NEW SUPER" stainless
steel impression trays
with retention rim.



AD-3304
"ANATOMIC" solid
regular stainless
steel impression
trays without
retention rim.



AD-3305
"ANATOMIC" solid regular
stainless steel impression
trays without retention rim.

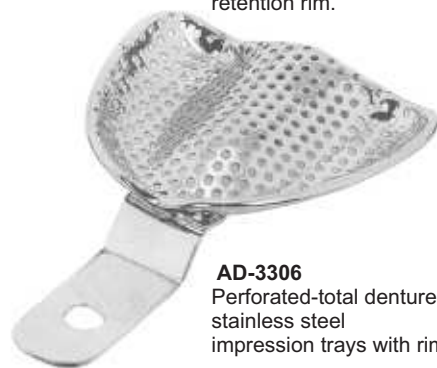

AD-3306
Perforated-total denture
stainless steel
impression trays with rim.



AD-3307
Perforated-total denture
stainless steel
impression trays with rim.

All Impression Trays Upper & Lower Type
are available in S, M, L & XL Sizes



AD-3308
"PERMA-LOCK" solid regular stainless steel impression trays with retention rim.



AD-3309
"PERMA-LOCK" solid regular stainless steel impression trays with retention rim.



AD-3310



AD-3311



AD-3312



AD-3313



AD-3314



AD-3315



AD-3316
Set of six

PACKINGS



AD-3317
Set of Eight



AD-3318
Solid stainless steel anterior depressed impression trays with retention rim.



AD-3319



AD-3320



AD-3321



AD-3322



AD-3323



AD-3324



AD-3325
Solid stainless steel anterior depressed impression trays with retention rim.

**All Impression Trays Upper & Lower Type
are available in S, M, L & XL Sizes**



AD-3326
Fig. 0 per bambini - for children



AD-3327
For narrow toothed upper jaws



AD-3328
Fig. 0 per bambini - for children



AD-3329
For partially toothed upper jaws



AD-3330
For partially toothed lower jaws



AD-3331
For edentulous upper jaws



AD-3332
For edentulous lower jaws



**All Impression Trays Upper & Lower Type
are available in S, M, L & XL Sizes**



AD-33 AD-33
Solid total denture stainless steel impression tray with rim.



AD-3334
Solid total denture stainless steel impression tray with rim.



AD-3335
"PERMA-LOCK" perforated regular stainless steel impression trays with retention rim.



AD-3336
"PERMA-LOCK" perforated regular stainless steel impression trays with retention rim.



AD-3337
Perforated stainless steel anterior depressed impression trays with retention rim.



AD-3338



AD-3339



AD-3340



AD-3341



AD-3342



AD-3343



AD-3344
Perforated stainless steel anterior depressed impression trays with retention rim.



AD-3345
Perforated stainless steel impression trays without retention rim for complete denture.

AD-3346
Perforated stainless steel impression trays without retention rim for complete denture.



08 SECTION

ARRICULATORS, DENTAL
& SURGICAL HOLLOWARES

Page 158-171

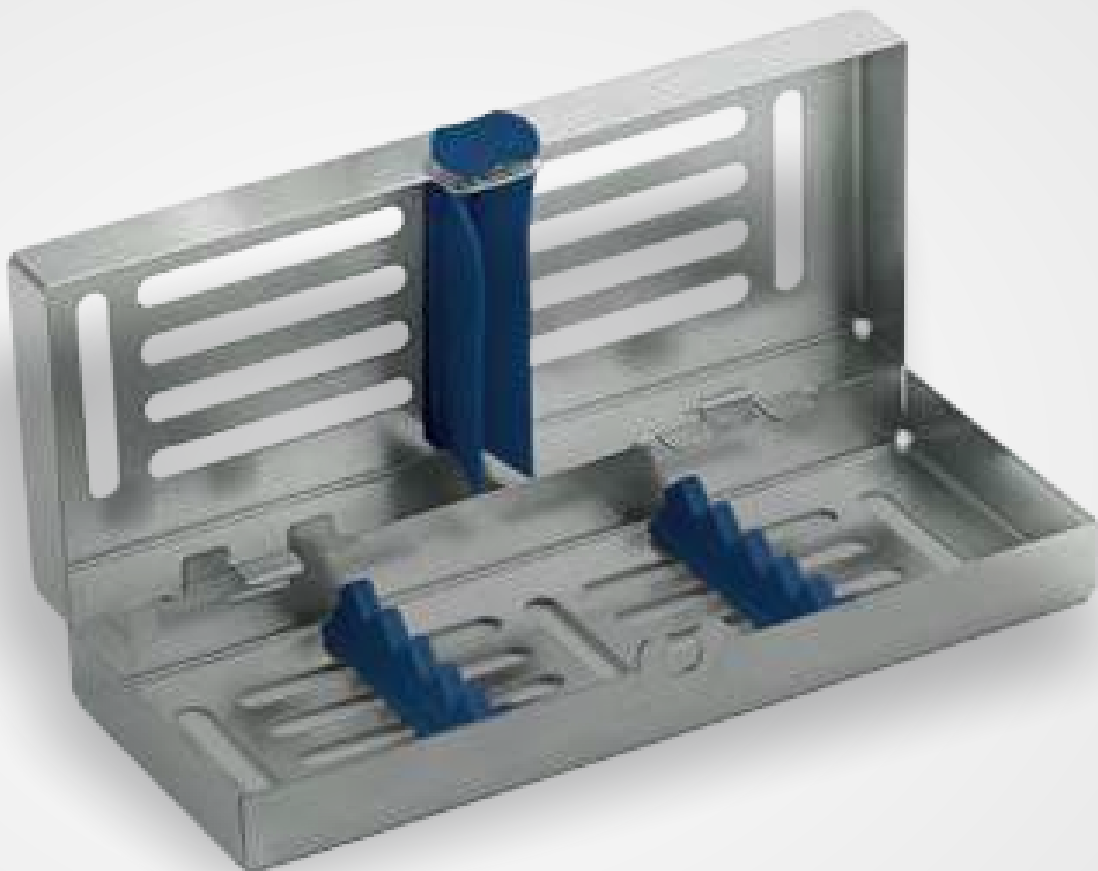



ODP-215
Articulator opening 180°
+4 mounting plates



ODP-216
Mounting plates



ODP-217
Occlusor

AD-218
Articulator with bearing rod
for 180° opening
+4 mounting plates



AD-219
Articulator with back rod
and hinge rod,
pure translation
movement allowed
+ 2 spacers
+ 2 magnetic mounting plates
+ 2 long screws
+ 2 short screws for plates.



AD-220
Magnetic Mounting Plate.
Die-casting aluminium tetlon
covered mounting plate
Applicable to Articulators

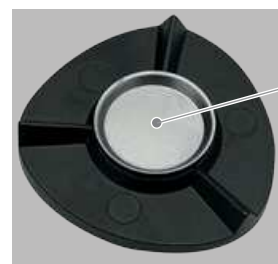
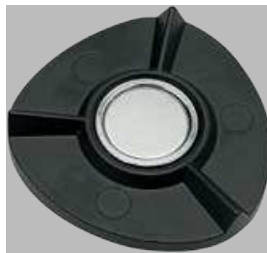

AD-221
Cast fastening washer
(10pcs. package)

PROTECTOR trays

economical protection of instruments
suitable for all common hygienical processes
fits exactly into standard trays



AD-222
PROTECTOR, 180 x 64 x 27 mm
for 3 instrument

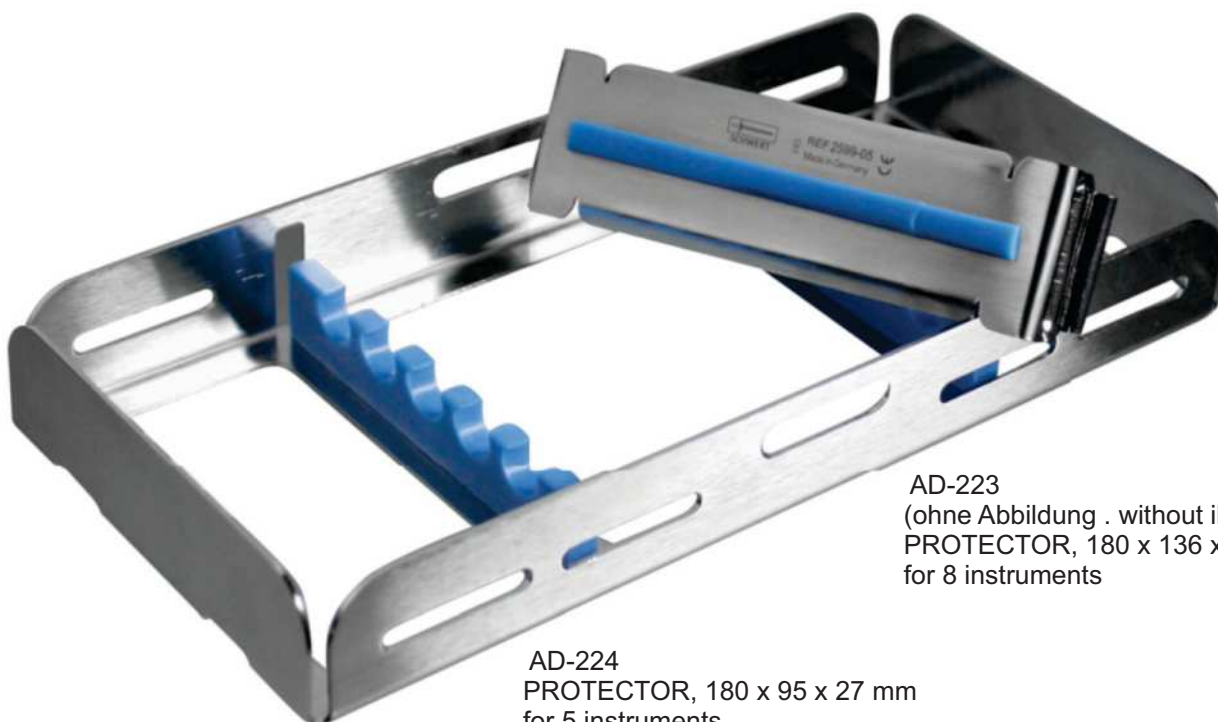

AD-224
PROTECTOR, 180 x 95 x 27 mm
for 5 instruments

AD-223
(ohne Abbildung . without illustration)
PROTECTOR, 180 x 136 x 27 mm
for 8 instruments





AD-2125
Stainless steel
Instrument tray

large size
(mm. 288x1 82x34)
for 20 instruments



AD-226
Stainless steel
instrument tray

Midi size
(mm. [82x] 44x34)
for 10 instruments



AD-227
Stainless steel
instrument tray
Mini size
(mm. 182x72x34)}
for 5 instruments



AD-228
Sterilization Cassette
HIGHER
(mm. 288x182x60]





AD-229
Perforated lid
(mm. 288x187x29)

AD-230
Perforated base
(mm. 284x183x17)

AD-231
Instrument tray complete
with perforated base,
perforated lid-and insert frame
for 16 instruments
(mm. 288x187x39)



AD-232
Solid lid
(mm. 288x187x29)

AD-233
Solid base
(mm. 284x183x17)

AD-234
Instrument tray complete
with solid base,
solid lid and insert frame
for 16 instruments
(mm. 288x187x39)

AD-235
Perforated lid
(mm. 183x144x29)

AD-236
Perforated base
(mm. 183x142x17)

AD-237
Perforated instrument tray
complete with insert
frame for 4 instruments
(mm. 187x144x39)



AD-238
Solid lid
(mm. 187x144x29)

AD-239
Solid base
(mm. 183x142x17)

AD-240
Solid instrument tray
complete with insert
frame for 8 instruments
(mm. 187x144x39)



AD-241
Insert frame
for 16 instruments



AD-242
Insert frame
for 4 instruments



AD-243
Aluminium insert frame
for 8 instrument



AD-244
Aluminium insert frame
for 11 instruments

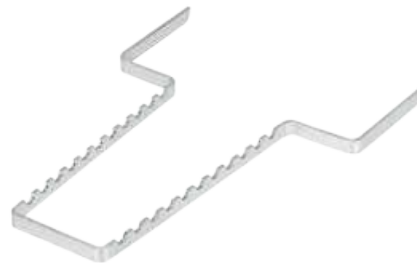

AD-245
Stainless steel kidney tray
(mm. 170x100x35)



AD-246
Stainless steel kidney tray
(mm. 250x140x40)





AD-247
Aluminium instrument tray
base - solid
(mm, 284x183x17)
grey



AD-248
Aluminium instrument tray
lid - solid
(mm. 288x187x29)
grey



AD-249
Aluminium instrument tray
base - perforated
(mm. 284x183x17)
grey



AD-250
Aluminium instrument tray
lid - perforated
(mm. 288x187x29)
grey

INSTRUMENT TRAYS

AD-251
Aluminium instrument tray
Base - solid
(mm.]142x183x17}
Grey



AD-252
Aluminium instrument tray
Lid - solid
(mm. 144x187x29}
Grey



AD-253
Aluminium instrument tray
Base - solid
(mm. 100x180x11}
Grey



AD-254
Aluminium instrument tray
Lid - solid
(mm. 103x182x10}
Grey



AD-255
Aluminium endodontic
Boxes, complete with lid
(mm. 204x105x54)



AD-256
Aluminium endodontic
Boxes, complete with lid
(mm. 204x105x54)



AD-257
Aluminium endodontic
Boxes, complete with lid
(mm. 100x44x54)



AD-258
Aluminium endodontic
Boxes, complete with lid
(mm. 100x44x54)



AD-259
Aluminium endodontic
Boxes, complete with lid
(mm. 100x44x54)



AD-260
Round aluminium
Endodontics boxes,
Complete with lif
(mm. 94 H. mm.70)



AD-261
Round aluminium
Endodontics boxes,
Complete with lif
(mm. 48 H. mm.62)



AD-263
Aluminium endodometer
(mm. 34 H. mm.48)
Round



AD-264
Aluminium endodontic
Instruments cleaners
(mm. 40 H. mm.30)
Without bottom



AD-265
Aluminium endodontic
Instruments cleaners
(mm. 40 H. mm.30)
Without bottom



AD-266
Aluminium waste
(cm. 7x7,5)



AD-267
Aluminium cotton
(cm. 7x7,5)



AD-268
Aluminium Endodontic
(mm. 100x40x40)rectangular



Aluminium Bur Holder Suitable For Cold
Sterilizing And Autoclaving At135°c

AD-270
Lid



AD-269
36 Holes Fg
(small Burs)



AD-271
36 Holes Ca
(big Burs)



AD-272
36 Holes Fg/ca
(small/big Burs)



AD-273
With Rim 24 Holes Ca
(big Burs)



AD-274
24 Holes Fg/ca
(small Big Burs)



AD-275
Lid



AD-276
48 Holes Ca
(big Burs)



KEY RINGS



Extracting Forceps Keychain
AD-277



Mouth Mirror
AD-288



Extracting Forceps Keychain
AD-278



Mouth Mirror
AD-287



Syringe Keychain
AD-279

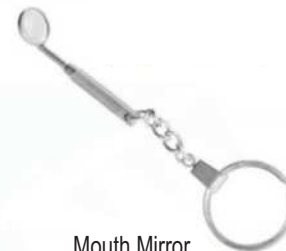

Mouth Mirror
AD-286



Syringe Keychain
AD-280



Caliper Keychain
AD-285



Mosquito Forceps Keychain
AD-281



Dental Tooth Keychain
AD-284



Impression Tray Keychain
AD-282



Tweezer Keychain
AD-283



AD-289



AD-290



AD-291



AD-292



AD-293

Address :

Chak Mandahar captain Mudasar shaheed
road Sialkot 51310 Pakistan

URL :

www.adeelnazind.com

Email :

adeelnazind@gmail.com
adeel_jay@yahoo.com

Phone :

+92 344 738 4130
(Whatsapp,Viber)